

THE PROFESSIONAL MAGAZINE FOR ELECTRONICS AND COMPUTER SERVICING

ELECTRONIC^{T.M.}

Servicing & Technology

October 1999

Servicing CD and DVD players

Switching power supplies

PROFAK
RCA/GE Video Cassette
Recorder Model VG7685

Monitor Servicing

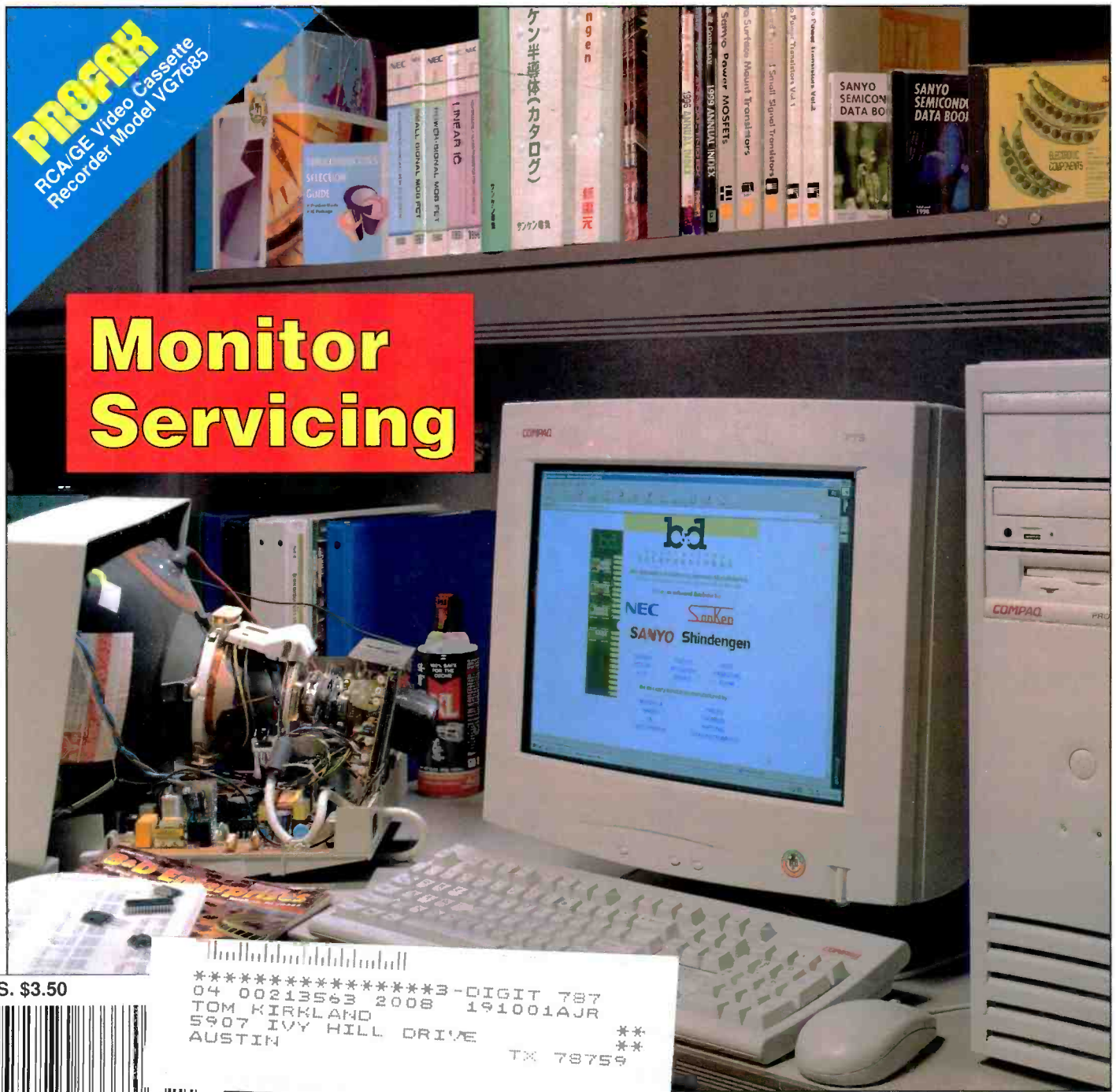

U.S. \$3.50



*****3-DIGIT 787
04 00213563 2008 191001AJR
TOM KIRKLAND
5907 IVY HILL DRIVE **
AUSTIN ***
TX 78759



Put Your Repairs On The Fast Track



LC103 REZOLVER™ IN-CIRCUIT CAPACITOR / INDUCTOR ANALYZER (5 Patents, 2 Pending)

Now, reduce the number of capacitors and inductors you unsolder for good/bad testing or replacement by 50% or more with the new LC103 "ReZolver"™.

- Quickly pinpoints bad capacitors and inductors with a one-button in-circuit test
- Complete capacitor tests for all four failure modes out-of-circuit
- Makes all tests, compares the results to EIA standards, and automatically tells you "GOOD" or "BAD"



CR7000 "BEAM-RITE"™ CRT ANALYZER & RESTORER

Easily test and restore CRTs with the most complete tests available for added profits and security!

- Full dynamic range to test all CRTs including:
Computer monitors, video displays, television, projection TVs, scopes and special application CRTs
- Only analyzer that provides simultaneous display of all guns tested
- New socket design allows faster and easier testing of projection TVs and computer monitors



HA2500 UNIVERSAL HORIZONTAL ANALYZER

In less than 3 minutes, localize ANY computer monitor horizontal or B+ problem WITHOUT a schematic - UNPLUGGED!

- Unique frequency lock and variable horizontal frequency allows you to quickly service all horizontal circuits
- Exclusive Horizontal Output Load Test makes setup and testing a snap
- Patented "ringer" proves the condition of flybacks and yokes in seconds - even a single shorted turn

Get A FREE CD! With Any Purchase Call For Details



SENCORE

1-800-736-2673 • www.sencore.com • e-mail sales@sencore.com

Circle (1) on Reply Card

contents

FEATURES

- 6 World's first TV tuner on a chip** by Alvin G. Sydnor
The tuner on a chip is a high performance dual-conversion tuner that supports the reception of multiple digital broadband standards, while maintaining compatibility with analog NTSC standards.
- 13 Whither consumer servicing** by the ES&T Staff
Comments by manufacturers, and seminars offered at a recent convention suggest that the future of consumer electronics servicing is bright.
- 14 High-Definition TV** by James Van Laarhoven
High-definition TV is now a reality; at least in some areas. Here's a brief rundown of some of the features and a description of how the magic of HDTV is performed.
- 19 Switching power supplies** by the ES&T Staff
This explanation of how these circuits work will help to simplify understanding and servicing of these devices.
- 24 Servicing compact disc and digital video disc players** by John A. Ross
Even though they're inexpensive, CD and DVD players can often be serviced economically. Read this article to see how it can be done.
- 44 Installing a mini-dish satellite system** by James Van Laarhoven
This article provides a complete rundown of how to hook up a mini-dish satellite system so that it goes smoothly.
- 50 Monitor servicing** by the ES&T Staff
This article provides a brief overview of personal computer monitor circuitry, and follows up with some technical tips on servicing some specific monitors.
- 54 Technology: Thermoelectric heating and cooling** by the ES&T Staff
Electronics circuitry used to cool as well as heat? Absolutely. Read this article to see how it's done.

DEPARTMENTS

- 2 Editorial
- 3 News
- 4 Books
- 12 Calendar
- 29 Profax
- 42 Literature
- 58 Products
- 60 Photofacts
- 62 Classified
- 63 Reader's Exchange
- 64 Advertisers' Index

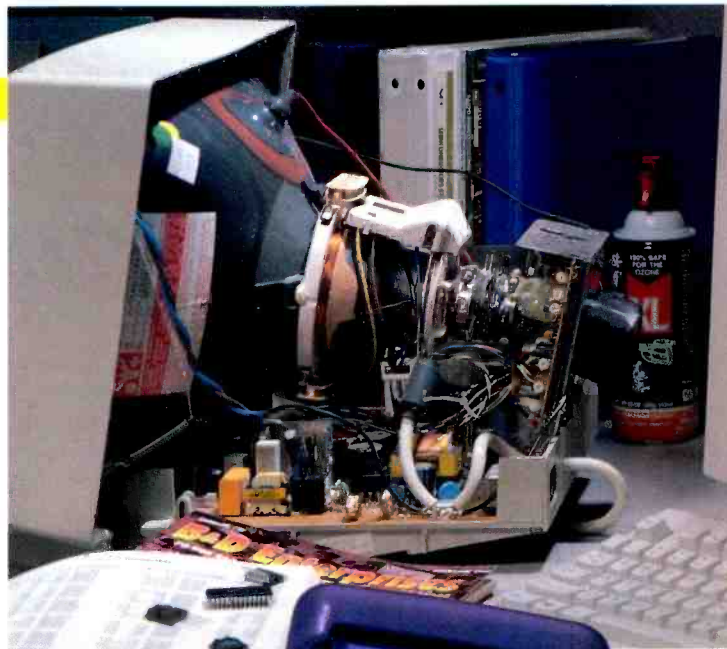

58



ON THE COVER

Computer monitors have a lot in common with other CRT displays such as television sets. They're also different in many ways. A competent consumer electronics service technician should have no problem servicing one of these devices, provided that he has the necessary technical information, tools, and replacement components available. (Photo courtesy B&D Enterprises)

42

Editorial

by Nils Conrad Persson

The basics

The story goes that when Vince Lombardi, coach of the Green Bay Packers during the '60s, and one of the most successful coaches in professional football, met with the players for the first time in getting ready for the next season, he started by holding out a football and stating "Gentlemen, this is a football." The point of that action was to emphasize that the basics, the fundamentals, are of the utmost importance in playing well. And those of us who spend part of an autumn Sunday afternoon watching football frequently hear that message being repeated. A quarterback will throw into an interception, or a running back will fumble because he didn't have the ball properly protected, and the announcers will chat with each other and say, "Those guys had better work on those fundamentals."

What's true of football is true of any other pursuit. If the practitioner does not have a firm grasp of the fundamentals, no matter how skillful he may be, he will occasionally run into trouble. It is certainly true of consumer electronics servicing, or just about any area of electronics. It is especially true of a discipline such as electronics, for a number of reasons.

For one thing, in electronics, there are a lot of fundamentals to learn, and none of those fundamentals are the kind of thing that a technician is going to pick up while having a casual conversation, reading a general interest book or a newspaper, or watching television. For another thing, electronics is a difficult, obscure, subject. Gaining a good understanding of the subject is achieved at least in part by simply living with it for a while, until the concepts begin to become familiar and comfortable.

Unfortunately, many, perhaps most, of us never did get a complete understanding of all of the fundamentals of electronics. If a student gets sick and misses a couple of days of school, he may miss being exposed to a number of the fundamentals and never even know it. Even more subtle, sometimes the mind is just not ready to grapple with and store some of the fundamental facts, even though the individual is in class and trying hard to get it, or trying hard to extract the material from a book.

Along those same lines, who among us hasn't had a poor instructor, and either never grasped certain fundamentals, or, even worse, got some of them wrong? And then, dagnabit, the electronics community seems to be bent on confusing us. Just when you got comfortable with the idea of voltage being an electromotive force (EMF), they tell us that, well, there really is no such thing as EMF, so quit using E to represent a voltage source and use V. Oh, and by the way, let's quit using "conventional current" and use "electron current" when constructing loop equations. Well, sure, you get the same result, but it just adds another confusion factor in grasping the fundamentals.

Something else happens as the study of electronics matures: someone comes up with a new way of looking at things, a new "paradigm" if you will, and some of us are exposed to it, and some of us are passed by. Here's an example. Do you remem-

ber magnetic "lines of force" and the idea of electromagnetic induction?

Most of us were taught that a magnet was surrounded by a magnetic field that consisted of "lines of force." If a wire were placed in that field, and either the wire, or the magnet, were moved, the lines of force "cut" the wire, and a current was induced in the wire. In a similar manner, if an alternating current were introduced into one wire, and another wire was placed close to it, the expanding and contracting magnetic field that the ac current caused surrounding the wire, "cut" the other wire, inducing a current in it. Transformers depend on this phenomenon for their usefulness. I learned about this "cutting" of a conductor by lines of force many years ago, and never had cause to think of electromagnetic induction any other way, even though I never really liked the idea of lines of force very well.

Recently, as I was doing some research to verify facts in an article that was to be published in *ES&T*, I revisited that phenomenon. I can't remember the text I used, but I think it might have been Sears and Zemansky's basic physics text. The explanation I found there made more sense than the idea of magnetic lines of force cutting a wire. It really isn't completely different, but the idea is somewhat different, and, much more elegant.

The idea is this: when a wire is in a magnetic field, if the intensity of the magnetic field in the vicinity of the wire is changing, then a current will be induced in the wire. You don't have to deal with the concepts of lines of force, or cutting, or any of that. It is simply the change of the intensity of the magnetic field, increasing or decreasing, that induces the current in the wire.

What all of this suggests, is that, as the years go by after we graduate from technical school, while we may feel that our education is pretty complete, from time to time we may find gaps in our knowledge of the fundamentals that we can't explain, or some principles not very well understood. This situation can present problems in performing diagnostic work, because, while the specific components may change: vacuum tubes to transistors, transistors to integrated circuits, and our perceptions of how things work may change, the fundamentals, the principles, do not change: V still equals IR, the sum of the voltages around any loop is still zero, and the voltage vs. current characteristic of a capacitor is still $i = C dV/dt$.

I know that my grasp of the fundamentals is filled with misconceptions and gaps, and I find that by reviewing the fundamentals from time to time, I occasionally fill in some of those gaps, straighten out some of those misconceptions. Most technicians could probably benefit from a similar occasional review.

With that in mind, in the article in this issue "Switching power supplies," we started with the very fundamental concepts of rectification, transformation, filtering, and regulation, and went on to describe the operation of a linear, and then a switching power supply. We hope the review is useful for most readers. ■

CEMA and NAB agree on new procedures for National Radio Systems Committee

The Consumer Electronics Manufacturers Association (CEMA) and the National Association of Broadcasters (NAB) have agreed on revised rules of administration for the National Radio Systems Committee (NRSC). The updated rules include more formal definitions of member obligations, an improved subcommittee structure and updated voting and standards development procedures. The NRSC, which is jointly sponsored by CEMA and NAB, is the forum for receiver manufacturers and broadcasters to evaluate, standardize, and promote new AM and FM radio broadcast technologies.

"This latest revision for the NRSC procedures, allows the Committee to be more responsive to the rapidly changing technological issues of the radio broadcasting industry," commented Edward Fritts, NAB President and CEO. "This collaborative, consensus building effort between broadcasters and manufacturers must remain agile and responsive to continue passing the benefits of new technologies on to consumers."

The NRSC is an industry-wide standards-setting body for technical improvements in the terrestrial over-the-air radio broadcasting systems in the United States. It has produced standards for improved AM broadcast and reception, evaluated high-speed FM subcarrier technologies, developed standards for the Radio Broadcast Data System (RBDS), and most recently, studied the feasibility of in-band/on-channel (IBOC) Digital Audio Broadcast technologies.

"Standards are critical for manufacturers to produce high quality products, with the features consumers demand, at an affordable cost," noted Gary Shapiro, CEMA president. "The NRSC brings together the broadcasting and receiver manufacturing industries to develop standards for technologies that improve the consumers' experience and create entirely new products and services."

CEMA is a sector of the Electronics Industries Alliance (EIA), the 75-year-old Arlington, VA-based organization representing all facets of electronics manufacturing. CEMA represents more than 500 U.S. manufacturers of consumer audio, video, accessories, mobile electronics, communication, information technology, and multimedia products.

CEMA's second audio summit a resounding success

Representatives from almost every major audio company gathered in Chicago to attend the second annual Consumer Electronics Manufacturers Association's (CEMA) Audio Summit. Building on the success of last year's program, 50 executives from 30 audio companies learned about customer-centered marketing strategies, and how to create better awareness for the home audio experience by effectively communicating with their customers.

"We in the audio industry know that we must use innovative marketing techniques to recapture consumer interest," stated Joe Richter, president of Kenwood USA Corp. and chairman of CEMA's Audio Division. "We came away with new approaches, techniques, and strategies for developing marketing and PR programs within our own companies. This program was about learning from well-respected marketing experts, following the lead of successful companies, and applying lessons to our own industry in reaching consumers in new and creative ways. The Summit stands as an example of CEMA's ongoing effort to help us grow our industry."

Leading the host of speakers at the Summit was Stephen Kraus, Ph.D., of Yankelovich Partners, Inc. who discussed "Rocking the Ages," a Yankelovich report on generational marketing. Sam Hill, co-founder of the Helios Consulting Group, gave an overview of the concepts detailed in his business best-seller, "Radical Marketing." Garth Hallberg, author of "Why All Consumers are Not Created Equal" and marketing consultant, discussed strategies for building brand loyalty and profits that go beyond one-to-one marketing. Susan Aldrich, a senior consultant with the Patricia Seybold Group, discussed how to create a profitable business strategy for the Internet and beyond, based on Seybold's bestseller, "Customers.com."

"The speakers we heard and interacted with helped validate some of our industry's current promotional initiatives, like our consumer direct mail campaign," Richter continued, "We also heard suggestions of how to better communicate with our customers with future programs, such as our audio training certification program, media outreach to Generation X, and our website to be launched this fall, www.AudioWeb.org."

CEMA urges FCC to continue protecting FM radio listeners from objectionable interference

Citing the results of its recent FM receiver interference study, the Consumer Electronics Manufacturers Association (CEMA) is urging the Federal Communications Commission (FCC) to maintain current protections limiting the radio frequency (RF) interference created by FM broadcasts. The FCC is considering eliminating some protections against FM interference in order to issue new low power FM (LPMF) broadcast licenses that would allow community radio stations to broadcast on or near the radio frequencies currently occupied by traditional FM stations. CEMA's study, initiated with support from National Public Radio and the Corporation for Public Broadcasting, found that lifting the current protections would result in the severe degradation of FM radio service to the listening public. CEMA detailed the study's findings and its concerns about the LPMF proposal in a filing submitted to the FCC.

(Continued on page 60)

Books

1999 Computer Monitor Troubleshooting Tips by M.I. Technologies, PROMPT Publications, 304 pages, paperback, \$49.95

The *1999 Computer Monitor Troubleshooting Tips* helps technicians tackle day-to-day monitor repairs. In this book are troubleshooting tips that include more specific detail and instruction, directing repair efforts with intensive description, and step-by-step guidance from point-to-point inside the monitor.

The CD-ROM contains M.I. Technologies, Inc. 1999 Windows Tech-tips Demo Monitor Repair Database, an ECG cross reference database with versions for Windows and DOS, a catalog directory containing a complete listing of M.I. Technologies, Inc. monitor schematics, a CAP-Wizard (In-Circuit Capacitor Tester), and a Donation Directory suggesting local school support. It also includes free FCC number identification software so the reader can cross reference model information to the original manufacturer and contact information.

The book contains over 3500 troubleshooting and repair tips listed by manufacturer name and model number featuring major names, such as Apple, Gateway, NEC, Viewsonic, Acer, Goldstar, Packard Bell, Wang, Compaq, Hyundai, Samsung, WYSE, CTX, IBM, Shamrock, Zenith, Dell, Mag-Tech, Sony, and many more.

Also included are repair procedures for the KD1700 series monitor including free schematics and parts list, and overview of how VGA monitors work, an overview of monitor EEPROM repair, an international monitor manufacturer contact listings, and IBM 3192 and WYSE 30, 50, and 60 terminal schematics.

PROMPT Publications, 2647 Waterfront Parkway E. Drive, Indianapolis, IN 46214-2041

Howard W. Sams Servicing Series: RCA/GE Televisions by Bob Rose, PROMPT Publications, 208 pages, \$34.95

This book is designed to give a detailed overview of the manufacturer and an in-depth analysis of various television chassis. The overview includes a history of RCA/GE/Thompson, discussion of test equipment, technician literature and software available, and a discussion on OEM parts versus generic parts. Each chassis analysis covers the five basic systems: power supply, system control, deflection, video, and audio.

PROMPT Publications, 2647 Waterfront Parkway E. Drive, Indianapolis, IN 46214-2041

The Computer Industry Almanac by Karen Petska-Juliusen and Egil Juliusen Ph.D, Computer Industry Almanac, Inc., 800 pages, hardcover, \$63, paperback, \$53

The *Computer Industry Almanac* is an annual reference book about the computer industry. The Almanac contains 800-pages, authored by two experienced industry observers. The authors call it the most cost effective resource book in the computer industry. *The Computer Industry Almanac* has thousands of facts that

summarize the industry. There are topics such as: Computer companies; Computer publishers; Associations, organizations, and user groups; Testing companies; Conference companies; Publications; Research companies; PR & marketing communications agencies; Conferences; and People.

The Almanac is full of rankings and awards for companies, people, and products, which have been excerpted from the business press and the computer press. One of the most popular chapters is the salary and wealth rankings of the top computer people as well as the average salaries for various computer-related occupations. It has summaries of computer market forecasts for hardware, software, and peripherals. There are also estimates of the number of computers in use for over 50 industrialized countries. A technology forecast focusing on 2000 to 2002 reviews the expected advances and product capabilities.

An introductory chapter explains the structure of the computer industry and defines the computer categories from personal computers to supercomputers. Software, peripherals, and service products are also categorized and defined. Additionally, there is a history of the computer, employment data, computer comedy, and much more. *The Computer Industry Almanac* was compiled using PCs and desktop publishing and all products used are listed in the *Computer Industry Almanac*.

Computer Industry Almanac Inc., P.O. Box, 4987, 926 Cambridge Drive, Buffalo Grove, IL 60089-4310

Dictionary of Modern Electronics Technology by Andrew Singmin, PROMPT Publications, 238 pages, \$35.95

The *Dictionary of Modern Electronics* emphasizes the latest technological terms and minimizes technology that dates earlier than the last 20 years. With over 75,000 clear and informative definitions, it covers everything from software to electronics packaging technology. Author Andrew Singmin has a lengthy interest in electronics and holds degrees in electronics semiconductor physics and solid state physics.

PROMPT Publications, 2647 Waterfront Parkway E. Drive, Indianapolis, IN 46214-2041

Howard W. Sams Laser Design Toolkit by Carl Bergquist, 336 pages, \$29.95

There is so much to lasers, that it's hard not to like them once you get to know them. You can't describe the thrill associated with watching that "red spot" on the wall, projected from a helium-neon laser you built with your own hands. Like most tubes, they have a life span of several thousand hours, and run at full performance for most of that span. This book will introduce you to this fascinating field, and help you complete exciting projects, like building your first HeNe laser, working with optics, constructing a laser light show, hologram processing, building a laser light meter, working with laser diodes, and more.

PROMPT Publications, 2647 Waterfront Parkway E. Drive, Indianapolis, IN 46214-2041

ELECTRONIC

Servicing & Technology

Electronic Servicing & Technology is edited for servicing professionals who service consumer electronics equipment. This includes service technicians, field service personnel and avid servicing enthusiasts who repair and maintain audio, video, computer and other consumer electronics equipment.

EDITORIAL

Nils Conrad Persson, *Editor*
(Internet e-mail: cpersedit@aol.com)
Alycia Nichol森, *Associate Editor*
(Internet e-mail: AlyciaEST@aol.com)
Richard S. Moseson, W2VU, *On-Line Coordinator*

CONSULTING EDITORS

Homer L. Davidson, *TV Servicing Consultant*
Victor Meeldijk, *Components Consultant*
John E. Shepler, *Audio Consultant*
Sam Wilson, *Electronics Theory Consultant*

PRODUCTION

Elizabeth Ryan, *Art Director*
Barbara McGowan, *Associate Art Director*
Edmond Pesonen, *Electronic Composition Mgr.*
Dorothy Kehrwieler, *Production Manager*
Emily Leary, *Assistant Production Manager*
Pat Le Blanc, *Phototypographer*

BUSINESS

Richard A. Ross, *Publisher*
Sal Del Grosso, *Accounting Manager*
Ann Marie DeMeo, *Accounting Department*
Judith Erickson, *Office Manager*
Catherine Ross, *Circulation Manager*
Melissa Gilligan, *Operations Manager*
Jean Sawchuk, *Data Processing*
Denise Kells, *Customer Service*

ADVERTISING SALES OFFICE

Kaprelian & Company, Inc.
521 Illinois Avenue, St. Charles, IL 60174
Tel.: 630-584-5333 Ext. 10 • Fax: 630-584-9289

Robin Torrey, *Director of Advertising*
Emily Leary, *Sales Assistant*

EDITORIAL CORRESPONDENCE:

P.O. Box 12487
Overland Park, KS 66212
913-492-4857



National Electronics Service
NESDA
Dealers Association, Inc.
Member, Electronic Servicing
Dealers Association

Electronic Servicing & Technology (ISSN 0278-9922) is published 12 times a year by CQ Communications, Inc. 25 Newbridge Road, Hicksville, NY 11801. Telephone (516) 681-2922. Periodical class postage paid at Hicksville, NY and additional offices. Subscription prices (payable in US dollars only): Domestic—one year \$26.95, two years \$49.95. Canadian—one year \$36.95, two years \$69.95. Foreign Air Post—one year \$44.95, two years \$85.95. Entire contents copyright 1999 by CQ Communications, Inc. Electronic Servicing & Technology or CQ Communications, Inc. assumes no responsibility for unsolicited manuscripts. Allow six weeks for delivery of first issue and for change of address. Printed in the United States of America.

Postmaster: Please send change of address notice to Electronic Servicing & Technology, 25 Newbridge Road, Hicksville, NY 11801.

CQ Communications, Inc. is publisher of CQ The Radio Amateur's Journal, Popular Communications, CQ Radio Amateur (Spanish CQ), CQ VHF, CQ Contest, and Electronic Servicing & Technology.

Online Ordering

When you think Internet,
think B&D Enterprises

W
W
W
·
B
D
E
N
T
·
C
O
M

AUTHORIZED DISTRIBUTOR FOR

NEC Shindengen

SANYO Sankyo AND OTHERS

TRANSISTORS
MOSFETS
DIODES
LINEAR IC'S
BIPOLAR IC'S
REGULATOR IC'S
OPTOELECTRONICS
THICK FILM HYBRIDS
POWER AMPLIFIER IC'S

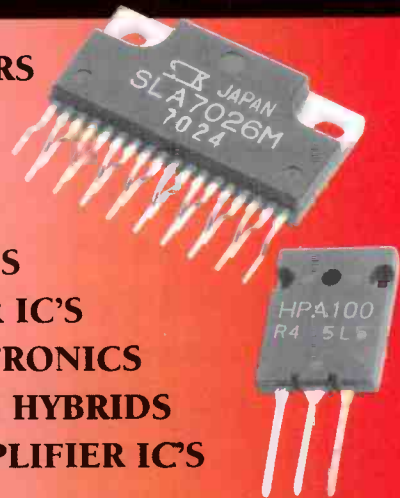

To keep up with the fast pace of distribution, we update our web site daily with new parts and prices giving our customers the edge they need to compete in a changing economy. Over 16,000 parts listed!



Visit our
Website at
www.bdent.com



B&D Enterprises

P.O. Box 460 Main & Liberty, Russell, PA 16345

TECH SUPPORT: 814-757-8300

FAX: 814-757-5400

Call today for your FREE Catalog

1-888-815-0508

Circle (62) on Reply Card

World's first TV tuner on a chip

by Alvin G. Sydnor

It was about 30 years ago when Gordon Moore predicted that the number of transistors on an IC would double every 18 months. This prediction became known in the industry as Moore's law and according to industry watchers, Moore's law is on schedule.

As an addendum to my earlier article "Early history of the transistor" that appeared in the May 1999 issue of this magazine, I thought it would be appropriate

Sydnor is a retired consumer electronics servicing technician.

to introduce the new single-chip TV tuner recently developed and introduced by Microtune Inc., Plano, TX.

Historical trends in TV tuners

The most critical and exacting section of a TV receiver has always been the tuner or front end. From the beginning, the tuner was designed to be jarred thousands of times a week as the channel selector was twisted from station to station and it was expected to withstand punishment without drifting out of its precise alignment.

Tuner manufacturing and repair became a specialty among a few component and sub-assembly manufacturers who supplied tuners to TV manufacturers.

By 1960, many of the bugs that had plagued the early tuners had been virtually eliminated by advanced design and construction. Many old timers will remember trying to eliminate microphonic squeals by swapping at least a half-dozen 6J6s to find one that worked properly.

The evolution of the TV tuner has evolved from the mechanical wafer-tier or

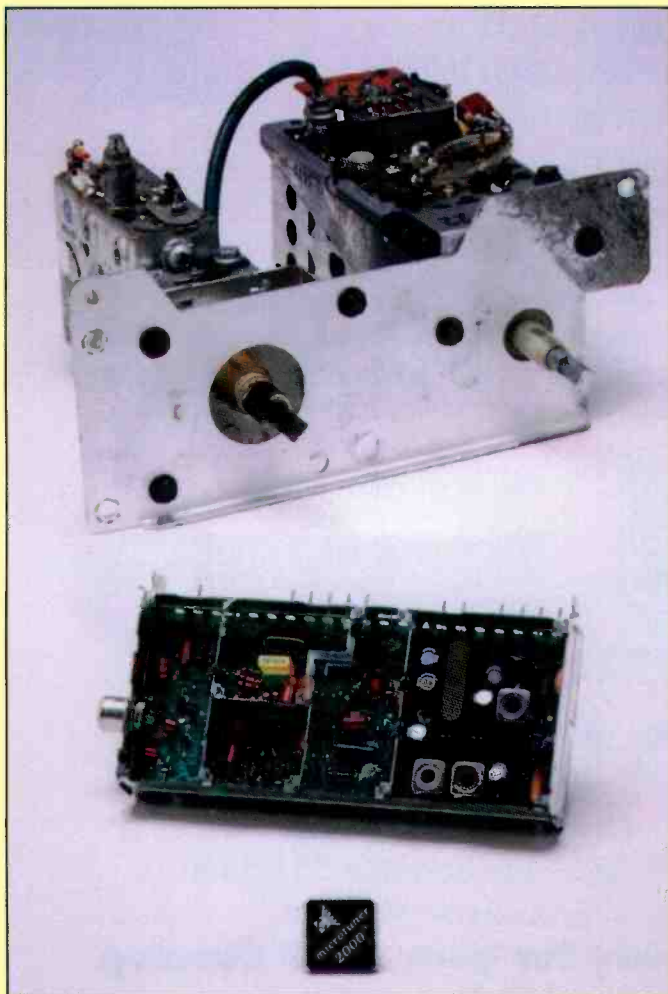

Figure 1. The TV tuner of today has come a long way from the mechanical wafer-tier or switch type shown here.



Figure 2. The tuner on a chip is a fully-integrated broadband tuner/receiver on a chip which is fabricated using IBM's proven high-performance BiCMOS process technology.

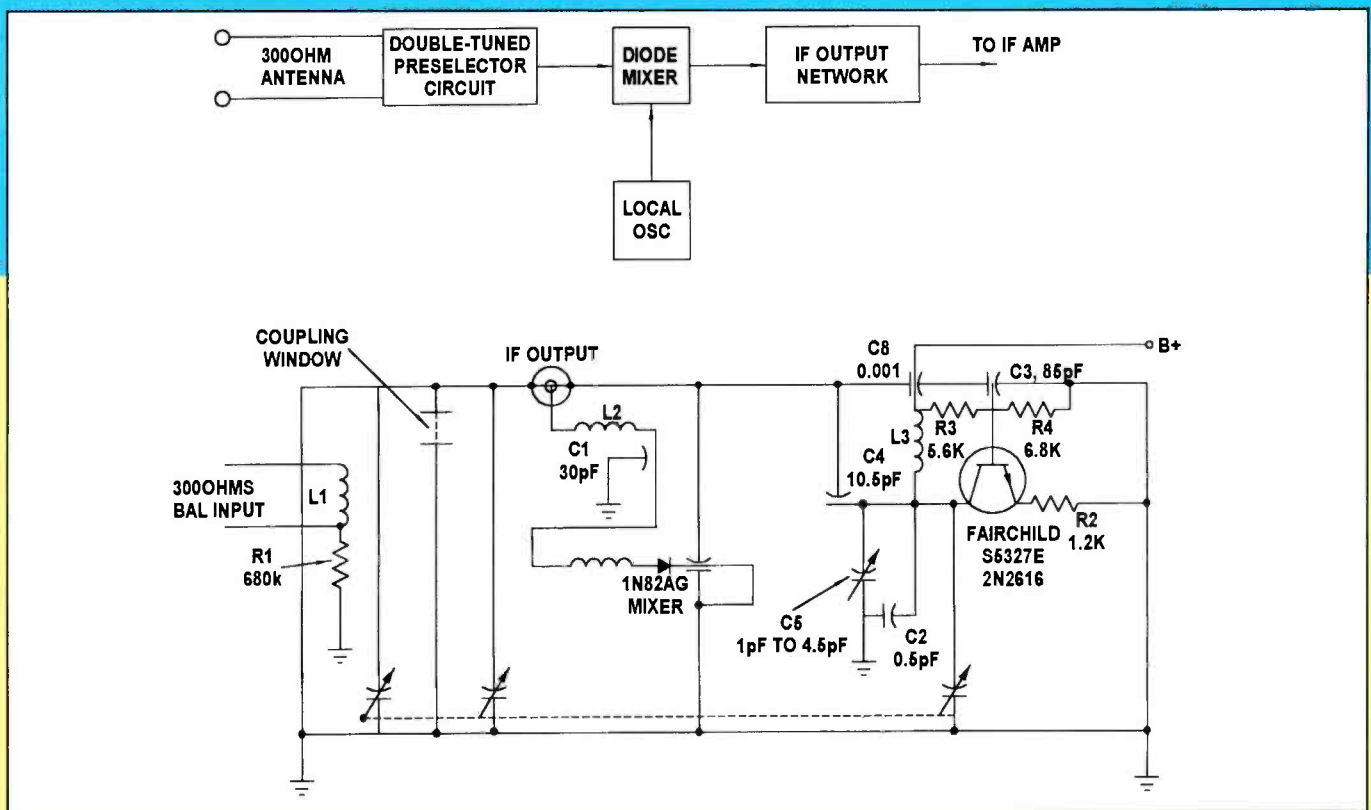

Figure 3. This is a schematic diagram of the 1962 Standard Kollsman Industries UHF tuner using a transistor oscillator.

switch type shown in Figure 1, which illustrates the old VHF and UHF tuner, to the present day tuner, and the new MicroTuner on a chip. To emphasize the small size of the tuner on a chip, see Figure 2.

The introduction of UHF

It was in 1964 that UHF TV was coming into its own and a few months before UHF was introduced, some manufacturers were featuring new combinations of VHF and UHF receivers. The dual VHF/UHF sets were outselling the VHF-only sets. During this time, we began to see the new all transistor UHF tuners.

Tuner manufacturers were including a double-tuned input sector, a diode mixer, and a local oscillator. Shown in Figure 3 is the 1962 Standard Kollsman Industries UHF tuner using a transistor oscillator. The 300Ω input line was coupled through L1 to the capacitive tuning element which included a coupling window, then into the mixer diode 1N82AG. The 680K resistor R1 grounds the input loop and returns any static to ground. Just think, all this was just a UHF tuner.

On January 26, 1999, Microtune Inc. introduced the world's first broadband tuner called the MicroTuner, which is one

of the most significant breakthroughs in TV tuner technology in the last 50 years. The MicroTuner is a fully-integrated broadband tuner/receiver on a chip, which is fabricated using IBM's proven high-performance BiCMOS process technology. The various input and output capabilities of the MicroTuner 2000 are illustrated in Figure 4.

The digital media era

The emerging digital media era is being driven by technology transitions, impacting networks, platforms, and advanced new applications. Today, we are beginning to realize that electromagnetic radiation was used initially for broadcasting mostly because of the economics; the spectrum was there and direct broadcasting into the home without wires was regarded as economical. In today's environment, any new service provider must consider both alternatives and the trend is beginning to favor the wires.

The steady advance of digital services are driving the demand for high speed data delivery using new broadcast sources such as cable, digital TV, and satellite.

DVD, direct broadcasting satellite, internet-multicast, digital audio broad-

casting, cable modem, digital cable, or digital terrestrial networks will be delivering entertainment and information to consumers at their home or office. The data can be formatted as video, audio, high-resolution images, large blocks of web pages, or data bases. The broadband networks, high-performance and cost-effective alternatives to today's voice/data delivery systems, will serve as the mechanism for the dissemination of this rich content to users world wide.

Spectrum over crowding

The electromagnetic spectrum crowding problems are more acute now than ever before. The transition to digital services, coupled with the FCC's policy of spectrum auctioning, has resulted in the consumption of existing "taboo" channels, which has traditionally been reserved to guarantee TV signal quality. Since its inception, portions of the assigned spectrum offer limited performance and impose severe restrictions on today's TV tuner. These restrictions prohibit the use of more than half of the available television bandwidth (the taboo channels) within a given locale. Since the FCC restrictions on the use of the taboo

channels has been lifted to allow the simultaneous broadcasting of digital and analog TV signals, the need for an advanced designed tuner is more evident today than ever before.

This over-population of the RF spectrum, coupled with the high-powered DTV broadcasting, could potentially result in interference and complete loss of the digital signal.

New technology requirements

The continual development of TVs, cable, and the internet has created complexity, and many forthcoming challenges in delivering high-speed digital video and data to the ever-expanding base of information appliances.

As television receivers absorb the intelligence and communication functions of the PC and as PCs integrate television and data being broadcast new and diverse, requirements become necessary. The traditional dedicated TV tuner can no longer meet the stringent demands of these emerging classes of consumer appliances. A new architecture featuring a low-cost universal gateway is required to receive and tune incoming video, audio, and data signals to any device from any broadband source.

Today's TV tuner is based on the 1970s design, which relies on labor-intensive assembly, which includes tuning and calibration of the frequency sensitive components. Many technicians have experi-

enced inherent inevitable drift in the mechanically-tuned components, which in time degrades picture quality and potential loss of a digital picture.

The MicroTuner MT2000

The major breakthrough and technical achievement created at Microtune is the integration of a broadband tuner/receiver into a single monolithic microcircuit. The fact that Microtune has accomplished this in a standard BiCMOS is even more significant as shown in Figure 6.

The MicroTuner 2000 is a high performance dual-conversion tuner that supports the reception of multiple digital broadband standards (QAM for digital cable and VSB for digital TV), while maintaining compatibility with analog NTSC standards. The MicroTuner 2000 supports television receivers and VCRs, as well as the next generation of convergent consumer electronic products, such as DTV, digital-ready, and multi-mode TV receivers, cable modems, digital cable set-top boxes, and PC/TVs.

The MicroTuner 2000 also addresses many of the problems associated with the emergence of digital TV broadcasting. Traditional off-the-air TV tuners were conceived at a time when few broadcasters considered the problems of congested airwaves.

Today, analog broadcast, high-powered digital signals, two-way pagers, aeronautical, and amateur radio compete

for the spectrum. Channel interference associated with the increasingly crowded spectrum is the source of many quality and performance problems. The electronic service technician is often confronted with the symptoms of ghosting and random loss of digital reception and at times a blank screen.

MicroTuner technology

Because of the broadcast of digital television (DTV) within the existing TV frequency spectrum, along with the continued broadcasting of analog television through (at least) the year 2006, the FCC has discontinued the requirement that adjacent channels be left vacant. It is expected that the entire TV spectrum will become more cramped. With the advent of digital television, including multi-casting and HDTV, television receivers and VCRs must be capable of accurately receiving and discriminating tightly-packed analog and digital signals being broadcast on 100-plus channel cable television systems. Present day tuners are not agile enough to handle closely-spaced, complex signals and to deliver high quality, interference-free pictures and sound. Tuners for digital circuits require higher close-in phase noise performance than is typical of existing dual-conversion tuners.

The MicroTuner chip offers a phase-noise performance of -85dBc at 10Hz offset, composite triple beats of less than -54dBc with 100 channels at a 15dBmV

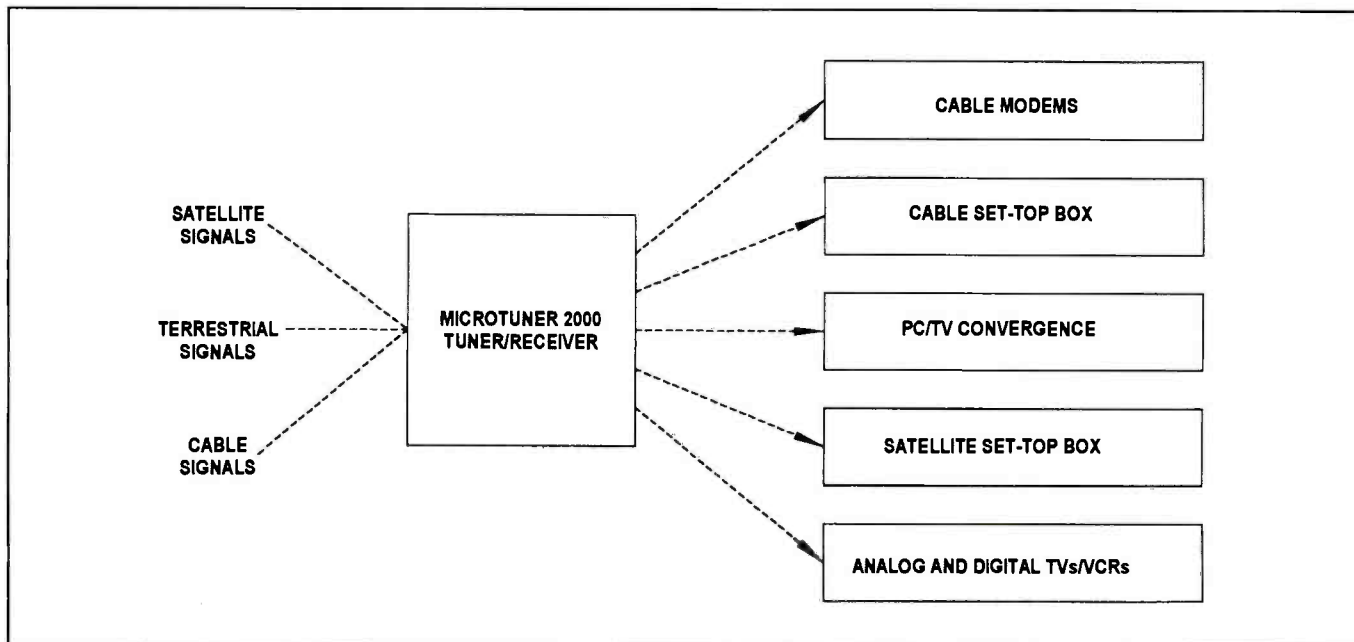

Figure 4. The various input and output capabilities of the MicroTuner 2000.

TUNER FEATURE	OFF-AIR TV TUNER	CABLE-TV TUNER	MICROTUNER
ARCHITECTURE	SINGLE-CONVERSION	DUAL-CONVERSION	SUPERSET
Cable Tuner-Of-Choice		✓	✓
Off-Air Tuner-Of-Choice	✓		✓
Low Distortion		✓	✓
Matched Input Impedance		✓	✓
Good Selectivity		✓	✓
High Image Reject		✓	✓
Internal Signal Containment		✓	✓
FCC Part 15.118 Compliant	✓	✓	✓
Wide Dynamic-range	✓		✓
Low Noise Figure	✓		✓
Low Phase Noise	✓		✓
Low Material Costs			✓
Low Labor Costs			✓
High Reliability			✓

Figure 5. A comparison of the capabilities of the tuner on a chip with other types of tuners.

input. The chip also offers 8 dB maximum noise figure and 30dBmV maximum input for 1% cross-modulation. This makes the MicroTuner 2000 ideally suited for analog, digital, off-air cable, and many of the new and advanced applications being developed daily.

The Microtune chip meets the perfor-

mance requirements for the crowded off-air and cable TV spectrum. With multiple system and circuit patents, including the world's only patent for an integrated television tuner on a single microcircuit, Microtune has successfully addressed the complex problem of cable-analog/digital tuners and has solved them in one cost-

effective monolithic device. The MicroTuner has an innovative RF-VLSI architecture that eliminates interference and distortion that is prevalent in environments, as well as providing excellent image rejection, impedance matching, and wide dynamic range. Since the tuner is a single semiconductor chip, it requires

PRELCO ELECTRONICS

FACTORY ORIGINAL SEMICONDUCTOR SALE

TOLL-FREE: 1-888-773-5268 • 908-851-8600 • FAX: 908-317-3737

ORIGINAL NAP® TUNERS	612556-1 13.52	613026-1 9.52	221-154 16.32	221-326 .32	221-571 29.36	221-791-01 5.84
340297-1 31.92	612565-1 7.20	613028-1 11.12	221-155-02 17.76	221-330 18.56	221-571-01 29.36	221-797 23.92
340354-2 32.80	612584-7 11.84	613028-3 11.12	221-157-02 1.92	221-343 .27	221-572 6.32	221-806 7.92
UV1336 36.00	612587-1 10.40	613030-1 11.12	221-158-03 1.20	221-345 5.28	221-576-01 7.92	221-808 15.12
ORIGINAL NAP® FBTS	612589-1 4.00	613037-1 12.40	221-160 3.76	221-360 6.24	221-586 7.04	221-808-01 15.12
361820-5 39.98	612590-1 3.92	613074-8 4.72	221-160-01 3.76	221-365 33.20	221-587-01 5.92	221-808-02 15.12
361872-2 31.98	612592-1 14.00	613085-3 15.92	221-164 2.80	221-365-01 33.20	221-590 7.92	221-812 28.24
361872-3 39.98	612624-1 15.04	613095-3 9.52	221-166-05 1.52	221-366 11.44	221-599 28.00	221-833 10.16
362127-2 31.98	612658-3 18.40	613101-1 9.52	221-166-07 1.27	221-369 6.32	221-599-02 27.84	221-836 25.12
362135-2 19.98	612668-2 6.32	613104-2 20.72	221-167-05 1.04	221-370 8.24	221-604-01 33.52	221-841 21.28
364071-1 19.98	612674-3 9.52	613143-2 4.72	221-169 5.60	221-371-01 34.00	221-620 14.32	221-845 6.32
364071-4 19.98	612682-1 12.40	613188-1 12.72	221-174-02 2.80	221-373-02 25.04	221-628-03 27.18	221-849 4.72
364075-2 19.98	612702-1 7.92	ORIGINAL SHARP® SEMIS	221-175 7.92	221-376 33.60	221-636 7.92	221-850 4.72
364077-3 19.98	612744-1 6.80	X0137CEZZ 3.12	221-175-01 7.92	221-379 2.80	221-641-01 6.32	221-857-01 4.72
364080-3 19.98	612745-1 8.72	X0179GEZZ 11.12	221-177 1.84	221-382-01 .96	221-648 24.72	221-860-01 28.64
364083-1 31.98	612766-1 7.92	X1190CEZZ 9.58	221-179-01 14.32	221-386 16.64	221-652-01 26.56	221-861 28.08
364085-1 19.98	612771-2 12.72	X2429CEZZ 8.80	221-179-03 14.32	221-418-02 15.76	221-656 4.24	221-870 15.20
ORIGINAL NAP® IC'S	612792-1 4.72	ORIGINAL ZENITH® SEMIS	221-190-01 11.12	221-419 4.80	221-657-50 5.52	221-875 28.56
612042-2 2.80	612796-4 16.72	221-42 2.40	221-192 .27	221-438 1.04	221-657-63 5.52	221-877-01 28.08
612069-1 2.80	612804-1 10.24	221-43 2.80	221-192 .27	221-465 23.52	221-658-01 9.52	221-877-02 25.44
612070-1 2.40	612818-1 7.92	221-45-01 2.56	221-193 2.32	221-466-01 1.92	221-680 14.32	221-894 11.12
612072-1 2.40	612818-2 7.92	221-48 .72	221-200 31.92	221-468 2.00	221-682-01 18.64	221-900-01 20.24
612076-1 3.84	612825-2 20.72	221-62 2.32	221-201-06 7.28	221-470 4.40	221-684-03 38.00	221-900-04 21.76
612076-2 3.84	612829-1 4.72	221-69 2.00	221-202 1.84	221-473 22.32	221-685-05 37.60	221-911A 39.92
612076-7 3.84	612846-1 11.12	221-77 4.00	221-206-02 24.96	221-475 11.60	221-701 13.20	221-913 21.36
612094-1 3.44	612854-1 10.40	221-78 2.32	221-209 3.04	221-476 7.92	221-703 27.12	221-913-02 21.36
612103-3 .27	612855-1 7.92	221-79-01 1.76	221-224 3.20	221-477 26.56	221-704 24.32	221-924-01 10.32
612120 5.04	612856-3 19.12	221-84 1.76	221-230 2.54	221-479-06 26.56	221-705 18.56	221-927 5.52
612160-3 3.12	612857-1 25.52	221-86 .88	221-235 1.20	221-485 9.52	221-709-02 27.52	221-940-02 16.48
612261-1 1.60	612865-1 7.92	221-87-01 3.12	221-243 40.48	221-492-01 7.92	221-712-01 27.20	221-940-04 16.16
612285-1 .56	612879-2 23.20	221-92 1.12	221-246-02 30.32	221-493 15.92	221-713-03 27.20	221-948-01 20.48
612312-1 9.52	612888-1 20.72	221-94-01 10.48	221-249 7.92	221-495-03 21.84	221-714-02 23.28	221-949-01 20.48
612313-2 11.12	612894-2 3.92	221-96 2.40	221-250-02 2.40	221-498 5.92	221-718-01 21.84	221-987-01 7.92
612331-2 7.76	612895-1 15.92	221-97 2.56	221-251 16.72	221-516 7.92	221-731 6.64	221-997-01 8.80
612338-3 4.72	612901-2 7.92	221-97-02 2.56	221-261 6.00	221-518-02 26.24	221-744 23.92	221-998-06 21.68
612342-1 10.32	612904-3 19.20	221-98 3.92	221-269 2.56	221-520 24.64	221-750 6.80	221-1006-02 20.64
612347-2 2.80	612906-1 20.72	221-100 4.72	221-274-01 .32	221-521 22.64	221-754-02 27.76	221-1006-03 24.08
612351-1 .72	612928-2 18.80	221-102-01 2.56	221-282 10.48	221-522 18.00	221-754-04 27.20	221-1006-05 25.68
612353-1 1.84	612928-3 18.80	221-103 2.32	221-282 6.88	221-524-01 21.36	221-761 .32	221-1028 4.40
612364-1 2.48	612929-1 20.40	221-104 2.80	221-285-02 15.60	221-528 3.12	221-773-02 27.20	221-1033 7.04
612405-1 2.00	612930-1 7.92	221-105 2.00	221-285-03 7.20	221-537 15.98	221-774-02 26.08	221-1046-01 4.80
612412-2 3.28	612933-2 11.12	221-106 3.12	221-296 3.92	221-538-01 31.04	221-776-01 27.20	221-1138-01 23.44
612463-1 2.00	612937-1 28.48	221-111-01 .27	221-297 3.76	221-542-01 7.92		
612469-1 1.20	612942-1 2.80	221-111-02 2.08	221-300 7.52	221-544-01 26.56		
612479-4 .27	612950-1 4.72	221-121 .64	221-301 1.20	221-545 4.00		
612480 1.20	612951-1 20.72	221-140 4.16	221-303 3.12	221-546 2.32		
612508-1 8.96	612952-2 4.72	221-141 1.76	221-305-02 37.68	221-552 3.98		
612552-1 7.20	612953-5002 15.20	221-142 14.08	221-306 17.52	221-554-01 33.20		
612553-1 7.20	612969-1 6.32	221-144 20.08	221-313-01 4.72	221-557 8.56		
	612970-1 15.92	221-147 3.12	221-314 9.20	221-563 15.28		
	612995-1 4.72	221-149-02 1.76	221-318-01 .38	221-564 6.40		
	613007-1 9.52	221-153 20.72	221-320-01 .58	221-565 23.12		
				221-568 12.40		

- Minimum order only \$ 15.00
- We accept MC, VISA, DISC, AMEX, Money Orders & Co. checks. No COD's
- Call for your FREE Super Savings Catalog

PRELCO ELECTRONICS CORP.
605 CHESTNUT ST., UNION NJ 07083

no mechanical tuning, thus making the device immune to drift and greatly increasing reliability.

Special dual-conversion architecture

A substantial portion of the MicroTuner is composed of a special dual-conversion tuner design that combines the best features from single and dual conversion tuners, as shown in Figure 6.

Single-conversion tuners are common in most all television sets and VCRs; dual conversion tuners are used in systems requiring higher performance, such as cable modems or cable set-top boxes. Single conversion tuners require front-end tracking filters and the use of discrete components that require complex adjustments at the time of assembly.

Additionally, because their band-pass filter characteristic moves across the band to "track" the selected channel, their performance is not ideal, resulting in less than optimal image rejection and selectivity and poor adjacent channel rejection.

The MicroTuner architecture

The MicroTuner's dual-conversion architecture eliminates the need for the

first filtering operation to be performed by a tracking band-pass filter. It converts the entire input band to a first intermediate frequency and performs filtering with a fixed band-pass filter. Since this first IF filter is fixed, no manual adjustments are required. The primary functions of the first filtering operation in a tuner are image rejection and band limiting. Band limiting is desirable since it reduces the aggregate signal level into the receiver's low noise amplifier (LNA) and first mixer. This reduces the power requirements and the cost of linear components that are required for single conversion tuners.

In the case of the MicroTuner, the LNA and first mixer receive the entire input band and handle the linearity issues through innovative circuit design. The first IF filter is complemented by an on-chip image reject mixer so that a simple, low-cost two pole ceramic resonator filter is adequate to achieve an overall 65 dB image rejection across the entire TV band. By way of comparison, single-conversion architectures typically have excellent image rejection in the low VHF band and acceptable performance in the

high VHF band and poor performance in the UHF band.

PC/TV interface via Microtune MT2500

In addition to the MT2000, Microtune has introduced their MT2500. See block diagram in Figure 6 and Figure 7. The MT2000 has an RF input and second IF output and is optimized for the consumer set-top box (STB) and cable modem. The MT2500 includes all the MT2000 functions, as well as IF demodulation, which makes it compatible for PC/TV convergence. The MT2500 chip is a full multimedia tuner providing both RF, IF, and baseband processing.

Both the MT2000 and the MT2500 tuner chips are broadband units capable of accepting RF input frequencies from 48MHz up to 860MHz. Both chips include a variable-gain low noise amplifier (VLNA), first and second mixers, and a frequency synthesis system.

The MT2500 adds NTSC video detection and FM sound demodulation, fully synchronous demodulation with carrier regeneration, AGC, AFT, separate sound

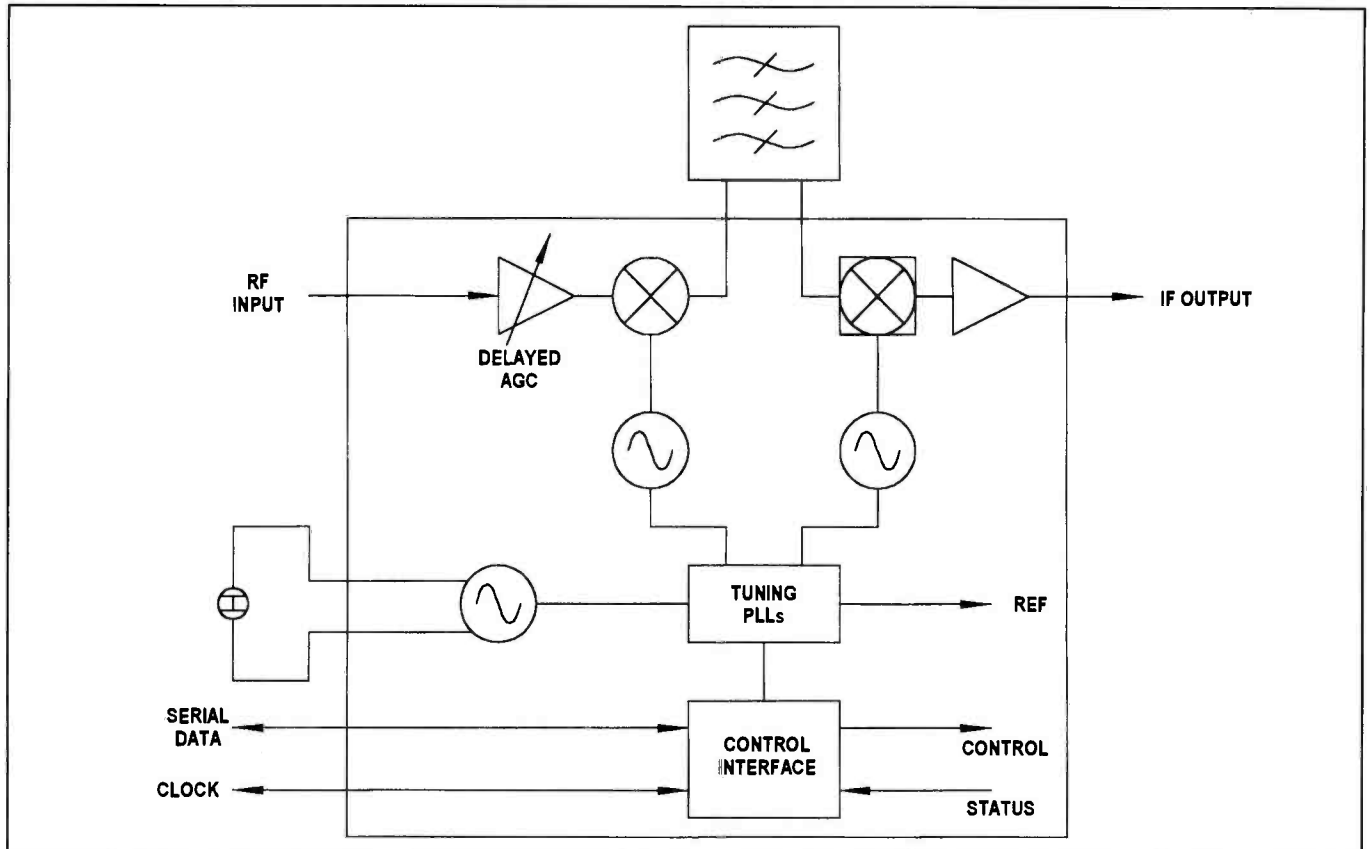

Figure 6. The schematic diagram of the tuner on a chip.

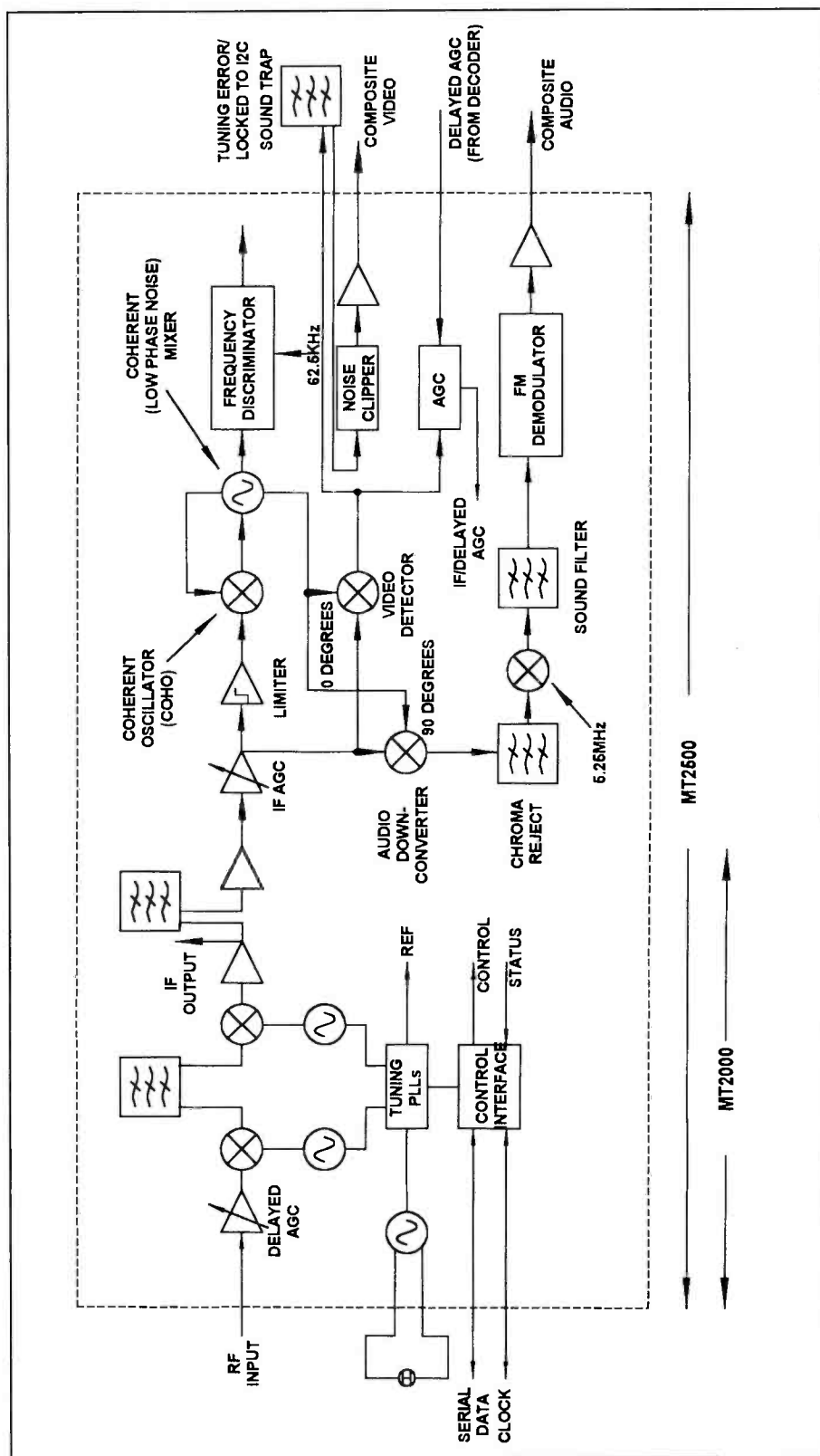

Figure 7. The MT2500 includes all the MT2000 functions, as well as IF demodulation, which makes it compatible for PC/TV convergence.

conversion circuits, including a sound IF limiter, and FM detection functions.

Both the MT2000's and the MT2500's LAN have variable gain, which provides excellent dynamic range, thus allowing

the single chips to be used in off-air, hybrid fiber coax (HFC), and cable applications without an external tracking filter.

Image rejection and channel selection of the up-converted IF spectrum is achieved

via an external 15MHz-wide narrowband IF filter, coupled to an internal image rejection mixer. The down-converted industry standard second IF center frequency of 44MHz allows the precise signal processing and detection of the video signal. The MT2500 has a gated video AGC that maintains a constant peak-to-peak baseband video output signal. FM detection is accomplished using a unique internal delay line, thus eliminating the need for external FM discriminators.

Interference issues

The MicroTuner designs include a number of oscillators and mixers, running large signals on a common substrate without creating interference problems. Typically, multiple oscillators on a chip create spurious signals that may include harmonics, parasitic emissions, or intermodulation products. Unwanted electronic coupling between circuits causes interfering spurious signals. In order to solve this problem, MicroTune relies on its own patented architecture and circuitry to minimize any interference. Its circuits minimize the generation of spurious signals while maximizing the rejection of those that might exist. It also employs micro-architecture and frequency plans that generate signals that are out-of-band to down stream processing.

Circuits and functions

The RF input circuit is a Variable-gain Low Noise Amplifier (VLNA), of which its design is critical because it plays a large role in setting the receiver's noise figure. The noise figure for the VLNA is typically 5 dB. It is important to consider that a TV receiver is a broadband system, which means that its input band covers several octaves, typically 50MHz to 860MHz, as opposed to a narrow-band system, such as a cell phone, which covers much less than one octave. In narrow-band applications, reactive components can be used to create LNA's, which isn't practical in broadband systems because a circuit cannot be tuned across the entire multi-octave band.

The first mixer up-converts the entire spectrum to the first IF frequency. The fully-integrated VLNA and the first mixer operating together, achieve a Composite Triple Beat (CTB) distortion in excess of -54dBc (dB relative to the carrier level) for any channel. CTB is third order dis-

third order distortion created by carriers beating against each other.

The external first IF filter operates at a frequency well in excess of 1GHz. The second mixer is an image rejection mixer, which down-converts to the second intermediate frequency. A major concern of RF design engineers is image rejection and this second IF mixer is of a specialized type with built-in image rejection whose purpose is to reject the image frequency of the 2nd mixer. In every amplitude modulated system, every signal has an image that is usually not desired. When down-conversion is performed, filtering can be used to attenuate the image signal. The combination of a mixer and a filtering function in an image reject mixer provides a greater amount of image rejection, in this case 65 dB.

In conventional TV tuners, local oscillators are frequency synthesizers made up of discrete components. In the MicroTuner, these local oscillators are fully integrated on the chip, thus generating all frequencies required for tuning from a single external crystal with a frequency resolution of 62.5kHz. The local oscillators are part of a complex frequency synthesis system in which the VCOs, the varactors, charge pumps, phase-frequency detectors, and dividers are all fully integrated on the chip. In terms of phase noise, the chip achieves a robust -85 dBc at 10kHz offset, which is excellent for both analog

and digital TV in both off-the-air and cable environments.

The second IF filter is a standard 44MHz TV filter. The IF amplifier is a variable-gain amplifier and automatic gain control (AGC) is applied between the IF amplifier and VLNA. The AGC gain range is 96dB. The video detector consists of a PLL which generates in-phase (zero degrees) and out-of-phase (90 degrees) signals. This PLL locks to the incoming picture carrier and generates in-phase and quadrature components. It uses the in-phase component to demodulate the IF video signal and uses the quadrature component to demodulate the IF audio.

Continuing on through the video path, a sound trap eliminates residual audio. Next, the noise clipper clips occasional video signal noise spikes. After filtering, the output is a full 4.2MHz baseband video signal. The output of the video detector is sampled to determine its magnitude and is then fed back to the AGC, IF amplifier, and VLNA.

On the audio side, there is an audio down-converter and chroma reject filter. An integrated continuous-time self-tuned filter serves as the sound filter. This highly-advanced filter automatically adjusts its own filter characteristics. The FM demodulator provides the composite audio output.

The entire MicroTuner chip is controlled through a standard series interface, which is compatible with I2C. This

allows the read-back of all status registers on the chip, as well as permitting device programming such as channel tuning. To tune a channel, registers are loaded in the tuning PLLs.

The old single-conversion tuners depended on adjacent channel vacancy to achieve acceptable performance. Changes will be necessary in the tracking filter to improve this performance to levels typical of tuners designed for cable television. Composite triple beat, composite second order distortion, and cross-modulation must be improved to provide acceptable performance for the new fully-utilized spectrum of the digital era.

Cable set-top boxes have predominantly used dual-conversion tuners for a variety of reasons, including in-band local oscillator leakage. The local oscillator of a single conversion is typically in the TV band. Impedance matching throughout the input band because the out-of-band impedance of a tracking filter typically provides a very poor impedance match to a cable.

This revolutionary silicon-based solution has encouraged more compact, living room-friendly box designs that not only lowers cost, but supports digital and analog signals. In addition, the chip will offer smaller products, faster assimilation into PC/TV, and eliminate signal interference from other electronic devices.

Microtune speculates that their single-chip TV tuner will enable a type of wireless web appliance to pull digital Internet data streams off sub-channels that are embedded in the new broad band digital TV signals. Look out — we may soon see the Dick Tracy wrist TV.

Microtune has also introduced three versions of their tuners on a chip: NTSC, Multi-standard PAL, and combination NTSC/PAL. These chips are high-performance, dual-conversion tuners that support international standards (NTSC, DOCSIS, VSB, DAVIC, etc. At the same time, they maintain compatibility with legacy analog systems, in this case, the multiple PAL standards (PAL-I,-B, -G,-H,-M,-D,-N). ■

The author wishes to thank Microtune's executive and engineering staff particularly James Fontaine and John Norsworthy for their help in providing technical information, photographs, and their review of my manuscript.

ES&T Calendar

EIA/CEMA Fall Conference
October 24-28, 1999
Palm Springs, CA

The 2000 International CES —
Your Source for Workstyle and
Lifestyle Technology
January 6-9, 2000
Las Vegas, NV

Digital Hollywood at CES
January 6-8, 2000
Las Vegas, NV

Consumer Electronics Manufacturers
Association (CEMA)
2500 Wilson Blvd.
Arlington, VA 22201-3834
703-907-7600
Website: <http://www.cemacity.org>



Whither consumer servicing

by the ES&T Staff

With the advent of HDTV, and so much other new high-tech consumer electronics, some servicers have wondered where they will fit in to the changing puzzle. Are the new products too complex for independent servicers to tackle? Do the manufacturers intend to support independent servicers in servicing these new products? Those questions were answered resoundingly at a recent convention, NPSC 99, in Dallas.

At a manufacturers' roundtable, service managers of the major consumer electronics manufacturers overwhelmingly stated that they fully expect independent service centers to service their products. Moreover, the support for servicers in servicing those high-tech products was evident in some of the seminars offered by the manufacturers. Here's a précis of what the service managers said, and a partial list of the seminars that were offered. Both are evidence of the continued reliance of manufacturers on the same independent service centers that are servicing their products today.

What the managers said

One manager said that his company will address the following to assist independent servicers: warranty rate structures, service parts availability and pricing, call center support, claims processing, partial payments, level of technical support, programs to help service centers complete service procedures on projection sets on the first call, and internet-based training.

Another service manager stated that the current service centers will be the service centers that service tomorrow's consumer electronics products. He continued that products will continue to come and go; even faster than they are today. He contends that manufacturers need a single internet launch pad via which manufacturers can identify appropriate service centers, and via which service centers can access service information, order parts, look up warranty status, etc.

A third service manager said:

Independent service centers will service this company's products, there will be an increase in consumer electronics products in the home, the products will be larger and more complicated, the products will be introduced at a faster rate. The service centers will have to become more efficient, hire and train good technical people, spend time on servicing, access information via the internet, use internet-based training materials, be able to properly run a business, rely on electronic business techniques as much as possible, cut paper, and file warranty claims electronically, in batches.

Another company sees independent servicers as partners working together with them. The mission of this company and service centers working together is: customer retention, bringing business and value into the corporation.

Yet another manager made this point about what service centers should do, and can expect in the future:

- This company thinks the future of consumer electronics service will be because manufacturers will be selling more high-end, large screen products, service will be in the home, products will be increasingly digital, service centers should look to antenna installation and component hookup business. He also emphasized that service centers should keep these ideas in mind: they will be servicing in the home, they have to maintain good quality of service (QOS), they will be called on to provide connection service, they will be called on to install antennas, they should be prepared to sell accessories on service calls, they need to become, or remain, technologically proficient, they need to become computer and internet savvy.

Technical seminars

The convention also included a number of technical seminars. Some of the seminars were no doubt more relevant than others, but a look over these seminar subjects will reinforce the idea that the manufacturers are in fact planning on

having independent service centers service their products, and they will give the reader an idea of where service is going.

- Basic DVD, by Pioneer
- Sony highlights: Circuit descriptions and troubleshooting of Sony's current direct view chassis (BA-4), which covers 13" through 27" TVs and incorporates the most advanced self diagnostic software. Also featured a brief description highlighting Sony's current analog NTSC sets and the future digital ATSC sets.
- Servicing switching mode power supplies
- Servicing Thomson's HDTV: includes basic principles, terrestrial broadcast, Dolby digital 5.1, and basic HDTV, DBS characteristics
- Servicing multi-media monitors
- Servicing LCD projectors
- Mitsubishi HDTV capable projection TV, VZ6 V15 chassis: Included an ATSC overview, featured service menus and alignments, signal processing, deflection, and high voltage.
- Useful computer software for the modern service center
- Introduction to programmable logic controllers and operator interface
- PC servicing
- Panasonic DTV overview: consisted of an introduction to digital television technology, a brief discussion of MPEG-2, AC3 and 8-VSB/16-VSB transmission systems, a discussion of the block diagram process stages of Panasonic's set-top-box, details of the video signal path stages in the DTV monitor, and a demonstration of digital convergence.
- HDTV update by CEMA (The Consumer Electronics Manufacturers' Association).
- Entering computer product servicing
- Hitachi HDTV overview: outline includes intro to ATSC, PS operation, ATSC-NTSC-Direct Module, NTSC route, 2.14 video route, deflection control, NTSC (4-mode operation), digital convergence.
- A demonstration of the Linux computer operating system. ■

High-definition TV

by Jim Van Laarhoven

The introduction of HDTV reminds some people of the early days of the VCR. Then the question was whether the industry standard was going to be Betamax or VHS? We all know what the answer to that question turned out to be. At the moment, however, the exact course that HDTV will take before everything settles down is still a mystery. The current plan is that by the year 2006 all analog TV signals will cease to be transmitted and only digital will remain, so we will most likely be seeing some decisions in the near future.

One of the many areas in question is that of the digital signal transmission. The NTSC (National Television System Committee) standard, which describes the system of transmission that television broadcasters and receivers currently used in the U.S., allocates 6MHz for earth-based or terrestrial channels, yet the bandwidth needed for some HDTV broadcasts (without compression) could be as high as 20MHz. Video and audio compression or channel reallocation have been considered to alleviate this problem.

Moreover, the method of transmitting the signal has met with some challenges. The industry is currently leaning toward terrestrial transmission (tower-based), though satellite is also a consideration. Receiving the digital signal is another matter that needs to be addressed. A standard TV will not decode the digital signal unless a set-top converter is installed. In addition, a standard TV receiving antenna will not work unless it is close enough to the transmitting source and is accurately positioned. If the receiving antenna is located at a greater distance from the transmitter, a new amplified antenna needs to replace the old one to receive the digital signal.

Even though some of the HDTV resolutions are currently in somewhat of a

Van Laarhoven is an independent technician and consultant for computer based lighting. These companies contributed information and photos to this HDTV article: Hitachi, Thomson/RCA, DirecTV.

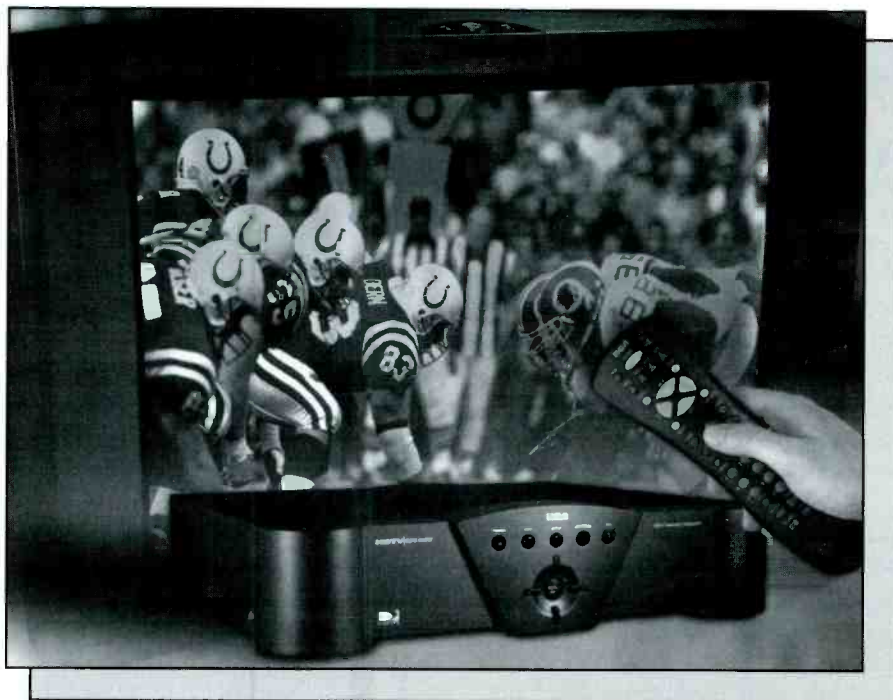

Figure 1. Combining a digital set top converter (foreground) with a digital high-resolution monitor and a high-quality sound system provides the viewer with high-quality video and audio. (Photo courtesy Thomson Consumer Electronics)

flux, it will eventually settle on some standard. Technicians will then have the job of learning those standards along with the technology that goes with them.

Picture quality is much better with HDTV

High-definition television in itself means better picture quality. Lines of resolution jump from the long-used 525 (interlaced or progressive) line/60 field per second, to 720 or 1080 lines. Likewise, the ratio between picture width and height increases to 16:9. Conventional TVs aspect ratio is 4:3. This change in picture quality opens up a wealth of options. This article will cover as many of these areas as possible.

A little more about DTV

DTV (Digital Television) refers to any TV system that operates on a digital signal. DTV may be broken down into two categories: HDTV and SDTV.

SDTV (Standard Definition TV) refers to DTV systems that operate off the 525 line interlaced or progressive standard. This system does not display the higher quality video that HDTV does.

Besides the higher quality picture that HDTV delivers, it also includes an advanced sound system. This audio system will be supported by Dolby AC-3 digital audio compression, which will include surround sound.

Current large screen prices are out of the range of most consumers (\$6000–\$10,000). However, a set-top converter can be purchased at around the \$650 dollar range (Figure 1). Since most households will opt for the more affordable set-top, we will discuss that further.

The set-top converter

The set-top converter in Figure 1 is capable of receiving many different signals including high-definition digital, standard digital, satellite digital, analog cable, and the standard UHF/VHF signals. Since most TV stations are currently transmitting more analog than digital, these options may come in handy. If the customer is currently using cable or over-the-air service and wants to change to satellite, the only modification worth mentioning is the installation of a mini-dish. It should be noted at this time that the set-top converter decodes an 8-level

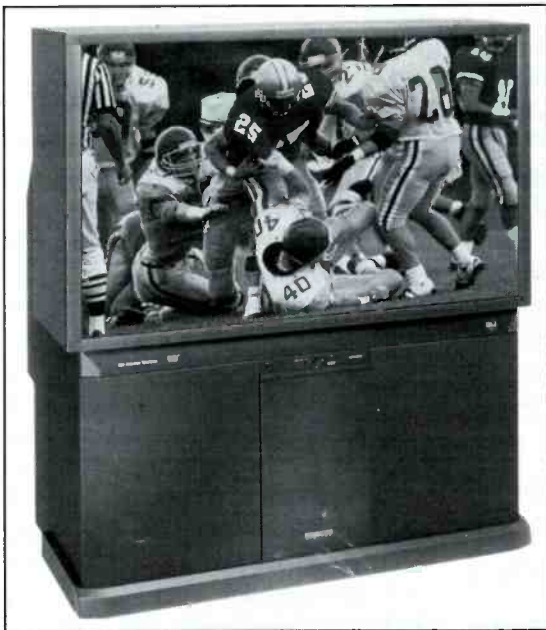

Figure 2. This high-definition set has all of the electronics needed for HDTV reception built-in. It doesn't need a set-top box. It is anticipated that eventually, all HDTV sets will be supplied this way.

of these formats. In addition, they will also supply equipment that will decode the complex audio signal.

Digital television transmission

There are currently over 1600 television transmitting antennas in the U.S. As of the writing of this article, somewhere around 60 antennas are transmitting digital (It

might be a good time to enter the transmitting tower business). Terrestrial transmission is accomplished on an 8-level vestigial sideband, or 8-VSB. It is derived from a 4-level AM VSB and then trellis coded into a scrambled 8-level signal (cable will use an accelerated data rate of 16 VSB). A small pilot carrier is then added and placed in such a way that it will not interfere with other analog signals. A flow chart showing the events of the data stream is depicted in Figure 3.

Many TV stations are trying to find ways to use their old towers to transmit digital. Some are considering the use of a slotted antenna that would be supported by the old tower. This could reduce the transitional costs of HDTV considerably. Engineers will have to analyze these existing towers to see if another transmission line and an additional antenna will place undue stress on the structure as a whole.

Built-in digital systems like the Hitachi portrayed in Figure 2, are the way the television industry will eventually make all of its sets. With about 600 million standard TVs currently in use by the public, it will be some time before the built-in units are as common as the color TV is today.

Manufacturers are using terms such as: Digital-ready, HDTV-ready, or HD-compatible. These terms do not mean the TV can read digital signals, only that they have a jack available to plug in a set-top decoder. Most of these types of TVs have enhanced screen resolutions.

Digital video formats

Eighteen digital video formats for HDTV were set forth by the Advanced Television Systems Committee (ATSC). The most common of these formats are the 720 and 1080. Combinations of interlaced, progressive, and frames per second mated to these two resolutions make up the majority of the 18. HDTV and set-top manufacturers have agreed to supply equipment to the public that will read all

the transmitting tower business). Terrestrial transmission is accomplished on an 8-level vestigial sideband, or 8-VSB. It is derived from a 4-level AM VSB and then trellis coded into a scrambled 8-level signal (cable will use an accelerated data rate of 16 VSB). A small pilot carrier is then added and placed in such a way that it will not interfere with other analog signals. A flow chart showing the events of the data stream is depicted in Figure 3.

Many TV stations are trying to find ways to use their old towers to transmit digital. Some are considering the use of a slotted antenna that would be supported by the old tower. This could reduce the transitional costs of HDTV considerably. Engineers will have to analyze these existing towers to see if another transmission line and an additional antenna will place undue stress on the structure as a whole.

HDTV receiving antennas

Receiving antennas for digital are also an industry in infancy. Very little is known about the wide-scale efficiencies of the standard antenna when it comes to receiving digital television signals. Many TV specialists believe that digital antennas must be considerably larger and be mounted much higher than standard analog antennas. One antenna manufacturer that is making headway in digital development is Thomson/RCA. They are currently providing dual-purpose antennas that are designed for terrestrial digital/VHF-UHF reception.



Your Ticket to SUCCESS

More than 40,000 technicians worldwide are Certified Electronics Technicians. IS CET offers Journeyman certification in Consumer Electronics, Industrial, Medical, Communications, Radar, Computer and Video. For more information, contact the International Society of Certified Electronics Technicians, 2708 West Berry Street, Fort Worth TX 76109; (817) 921-9101.

Name _____
 Address _____
 City _____
 State _____ ZIP _____

- Send material about IS CET and becoming certified
- Send one "Study Guide for the Associate Level CET Test." Enclosed is \$14.95 (includes postage/handling). *TX residents — include 8.25% sales tax.*

ES&T

Circle (2) on Reply Card

To Order Back Issues

Only \$4.00 Per Issue

Complete your collection today.

Check, Money Order, Mastercard, VISA, Discover and AMEX accepted

CQ Communications
 25 Newbridge Road, Hicksville, NY 11801
FAX: 516-681-2926

For Faster Service
CALL 516-681-2922

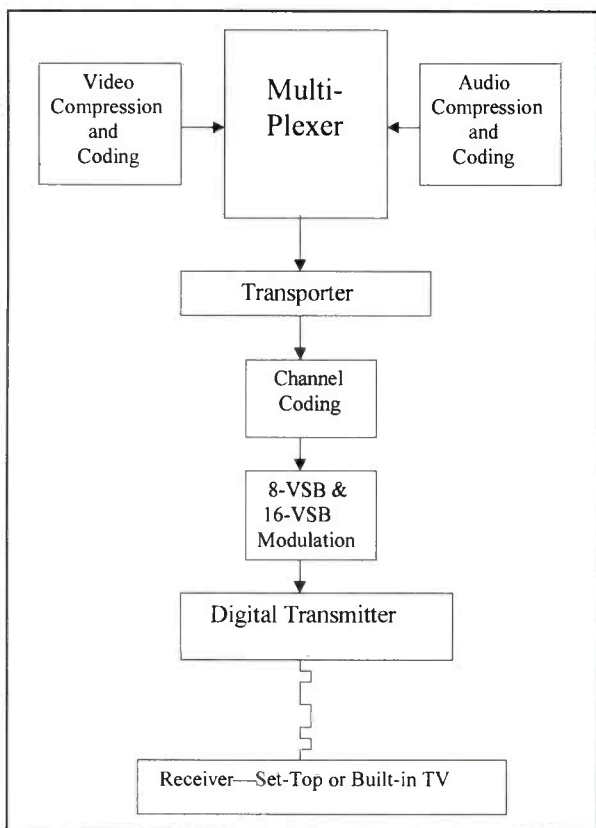

Figure 3. This chart shows the flow of the HDTV digital data stream from the originating broadcast station to the viewer's television set.

Satellite systems are already one step ahead of most broadcasters since they already transmit digital. DIRECTV has one HDTV channel currently in use and plans another by the year's end. Digital satellite systems will have an easier transition to high-definition broadcasting than will its earth-bound counterparts.

Compatibility concerns

A question that is being asked by technicians and consumers alike is: "Will standard VCRs, DVDs, and other entertainment products be compatible with this new system?" The consensus on this answer seems to be, yes. Most manufacturers are including composite video and analog inputs in their

digital equipment and claim 100% compatibility on peripherals.

Transfer of data via HDTV

It is agreed upon that the future of HDTV has potential in many areas. One of these is the transfer of data and the ability to interact with it. Exactly what type of data that can be transferred is limited only by the imagination. It probably will be an ongoing process of discovery, much like what has been happening in the case of the Internet. Another possibility is using your TV screen as a computer monitor. With HDTV producing a 1050-line by 600-pixel image, it compares well with a high-quality computer monitor. Manufacturers are also planning to make tuner cards that will allow your PC to receive HDTV signals. It would sure handle the data part of the transmission well.

Digital TV, and more, is on the way

Digital television is integrating itself steadily into the consumer market. Our imaginations can foresee the future television becoming a multi-purpose device that unifies computer, entertainment, and video communication. HDTV is one indicator of that future. ■

CAN'T FIND A PART?



CEMA's 2000 Replacement Parts Source Book

Look into the best, most up-to-date information on sources for replacement parts. Lists many consumer electronics companies, including toll-free (800) numbers, addresses and ordering procedures for replacement parts. One of CEMA's most popular items, the Source Book helps you find the parts and technical literature you need for efficient repair. Order your 2000 edition now. Cost: **\$8.00**

For credit card orders, call **703-907-7670**.

Send check or money order to CEMA.

Purchase orders accepted from educational institutions.

FAX to **703-907-7968** or mail to:

**CEMA TES Department,
2500 Wilson Blvd., Arlington, VA 22201.**

Switching power supplies

by the ES&T Staff

Before we get into the concept of power supplies, let's just consider the idea of power supplies. What is a power supply? What does it do? How does it operate? It may sound a little simplistic, but many times ideas flow best when we start at the very beginning.

The function of a power supply is to accept some kind of input voltage at its input, and to provide a specified voltage (or voltages) at its output.

To further narrow the subject here, we'll be talking about power supplies that are built as part of the internal circuitry of consumer electronics products (TVs, VCRs, CD players, stereo receivers, etc.). These power supplies have as their input a 110Vac power line voltage, and as their output(s), a voltage or voltages that are required to power the various functional circuits in the products.

What does a power supply do?

As mentioned earlier, a power supply is fed some existing form of voltage source, and operates on it in some way to make it suitable for use in powering a circuit. When the source is an ac power line voltage, and the circuits being powered are electronic circuits that need a dc voltage, the operations that have to be provided by the power supply are: *rectification*, *transformation*, *smoothing* (also known as *filtering*), and *regulation*.

To expand a little more on that idea, we have to convert the ac into dc (rectification), change its voltage to the value of voltage required by the circuit to be supplied (transformation), smooth it out, since the dc from the rectifier is pulsating, and regulation (keeping the power supply voltage constant, or nearly so, regardless of changes in the input voltage, or changes in the load).

It should be said here, that these functions of the power supply are not necessarily performed in the order stated. In the case of a linear power supply, the usual order is transformation, then rectification, then smoothing, and regulation. Let's take a closer look at those functions.

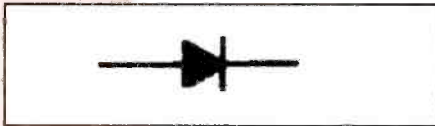

Figure 1. The diode passes current in only one direction. That makes it a useful device as a rectifier characteristic.

Rectification

Every technician is familiar with the idea of rectification. The component that's used to perform this function is shown in Figure 1, a diode. A diode is a wonderful device. It will pass electrical current only in one direction.

When an ac current is applied to a circuit consisting of only a diode, the output will be a pulsating dc (Figure 2). Oh, yes, one other thing; only half of the waveform will be available at the output. The other half will be discarded. In other words, in devices that use half-wave rectification, half of the electrical power applied to them is wasted, just thrown away. That's why it isn't used much any more, if at all.

In place of half-wave rectifiers, we now use *full-wave* rectifiers, such as the *bridge rectifier* shown in Figure 3. This rectifier inverts the alternate half cycles of the power-line voltage, and the output is a pulsating dc as shown.

Transformation

When the 120Vac line voltage is rectified, the pulsating dc has an effective value somewhere above 120V. For circuits that require 5V, or 12V, or 300V, that voltage is not very useful. In the case of linear power supplies, transformation was the first step in the process (Figure 4). As you recall, a transformer isn't much use in changing the level of a dc voltage, so trans-

formation must take place before rectification in a linear supply. As we'll see later, since the dc voltage in a switching power supply is switched at a rapid rate, it can be coupled through a transformer, so rectification takes place first in a switcher.

Regulation

The power supply voltage that's available after transformation and rectification, regardless of which step takes place, isn't too useful, because it will vary, depending on the power line voltage, and the load placed on the power supply. A very important part of the process of creating a power supply voltage is regulation. There has to be some kind of component that maintains the power supply voltage at a constant value regardless of the variations in the line voltage or the load.

A very simple form of regulation can be performed by simply placing a zener diode in the circuit, as shown in Figure 5. The zener has a voltage versus current characteristic such that when it's reverse biased, it becomes almost an open circuit, much as a regular semiconductor diode, until the voltage reaches a certain point, then the diode immediately begins to conduct heavily, and the voltage remains nearly constant at the point at which the conduction began. This is known as the zener, or avalanche region of the diode.

As long as the raw voltage output of the rectifier is greater than the zener point of the diode, the diode will be reverse biased to its zener region, and the voltage across it will remain nearly constant.

A practical linear power supply

Use of only a zener diode will provide a degree of regulation, but the situation

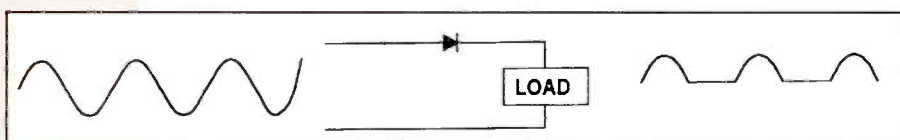

Figure 2. When an ac signal is applied to a diode in this manner, it passes only the positive going half cycle, in essence, throwing half of it away.

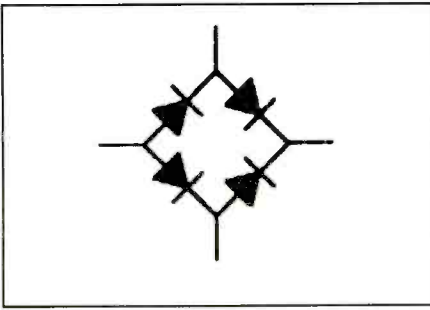

Figure 3. In place of half-wave rectifiers, we now use *full-wave* rectifiers, such as this *bridge rectifier*. This rectifier inverts the alternate half cycles of the power-line voltage, and the output is a pulsating dc as shown.

will be improved with the addition of a transistor, as shown in Figure 6. In this configuration, the transistor acts as a sort of variable resistor.

Linear power supplies have a long history of good service. Properly designed, they provide tight regulation and are reasonably reliable. But they have some drawbacks. For one thing, the pass transistor in the regulator segment of the circuit is on constantly. That means that the transmitter's dissipating power constantly, and therefore, the supply is less efficient that designers would like.

Another drawback is that the transformer needed to change the voltage of the ac line operates at 60Hz, the line frequency. In order to provide the necessary power to the unit at that frequency, the transformers must be fairly large. That adds a lot of weight to the unit, and uses a lot of copper.

The switching power supply

The switching power supply eliminates both of those drawbacks at one fell swoop. Because the switching takes place at a frequency much higher than the 60Hz line voltage frequency, the transformer used can be much smaller and lighter, and use less precious copper. And, because the switching transistor is on and drawing current only during a part of the cycle, the system is far more efficient than an equivalent linear supply.

A lot of technicians seem to have a hard time dealing with switching power supplies, but they're really not a lot more complicated than a linear power supply, just different, and they operate by principles that may seem just a little alien. But the general idea is still the same, to pro-

vide a constant dc voltage, or more than one constant dc voltage, to the circuits in the product that need them.

Here's the key to the operation of the switcher. The switching action does two things: it provides the voltage regulation necessary to provide a constant output, and it creates a high frequency alternating current signal that can be coupled through the transformer to the secondary side of the supply.

Let's first take a look at a simple, generalized switching power supply, just to get a grasp of the general principles. Then we'll take a look at a real world switching regulated power supply and see how it operates, and how it can fail.

An idealized switching power supply

In the circuit of Figure 7, the bridge rectifier rectifies the 120V, 60Hz, line voltage. The rectified voltage is smoothed by capacitor C1, and connected to the primary winding of the transformer through the switching circuits. The feedback winding, on the primary side, is coupled to the secondary winding. The feedback signal is connected to inputs that are used to control the switching of the switching circuits. As long as the sensed voltage is at or below the specified value, the switching circuits will continue to operate. If the voltage exceeds the specified voltage, the switching circuits will stop operating until the voltage drops below the specified value.

A real life switching power supply

Figure 8 is a simplified drawing of the main power supply of the Thomson Consumer Electronics CTC195/197. When this set is first plugged in to the 120Vac power line, the combination of the bridge rectifier, CR210, and the filter capacitor C208 produces approximately 150Vdc of raw B+. This voltage is fed to the primary winding (Np) of transformer T101. The other end of T101 (pin 4) is connected to the drain of power MOSFET (metal-oxide semiconductor field-effect transistor) Q101. The source of transistor Q101 is connected to ground via resistor R124 (0.22Ω, 2W).

The MOSFET, Q101, needs a signal at its gate from pin 5 (output) of U14101 in order to turn on and initiate operation of the power supply, but until the power supply is operating, there's no voltage from

the power supply at pin 6 (V_{CC}) to power the IC. This little problem is overcome by providing a supply voltage to U14101 pin 6 from the raw B+ via resistor R104.

With this voltage at pin 6, U14101 generates a voltage at pin 5. This voltage is applied to the gate of the MOSFET. With a signal applied to its gate, Q101 turns on for the first time, which results in a current through the primary (Np) of transformer T101 and transistor Q101.

The 300Vdc raw B+ also connects to the circuit consisting of R146 and C146, a simple RC network. This network is connected to pin 2 of U14101. Until IC U14101 applies the signal from its pin 5 to the gate of Q101 to turn the MOSFET on, the control logic in the U14101 maintains a condition such that C146 is held in the discharged state. Once Q101 is turned on, C146 is allowed to start charging. In this manner, the circuit consisting of R146 and C146 serves as an indirect sensing circuit for the current through the primary of T101.

Once Q101 is turned on, as current is flowing through the primary of T101, current is also flowing through R146 and C146, charging the capacitor. When the voltage at the top of the capacitor reaches approximately 3V, the voltage at pin 2 of IC14101 will also be at 3V. At this point, the IC shuts off drive to the MOSFET, stopping the flow of current through it and the primary of T101.

When the current through the primary of T101 stops abruptly, the magnetic field surrounding the winding collapses. This collapsing magnetic field induces a current in the secondary of the transformer, effectively transferring the energy stored in the magnetic field into current in the secondary. The energy transfer is also coupled into the feedback winding (Nf) between pins 8 and 9 of the transformer.

The voltage developed at pin 8 of T101 is rectified by CR111 and filtered by C127. This voltage is applied to pin 6 V_{CC} of U14101 and becomes the *run* V_{CC} for

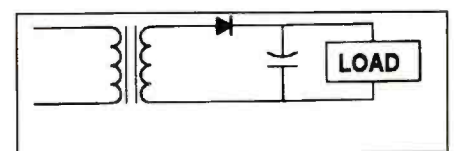

Figure 4. In the case of linear power supplies, transformation was the first step in the process. A capacitor has been added here to provide smoothing of the pulsating dc.

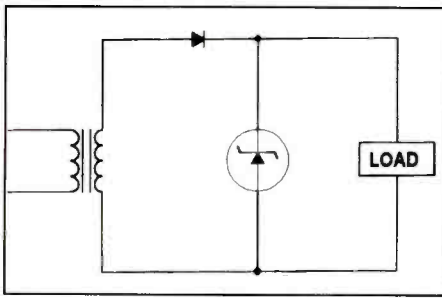

Figure 5. A very simple form of regulation can be performed by simply placing a zener diode in the circuit, as shown here.

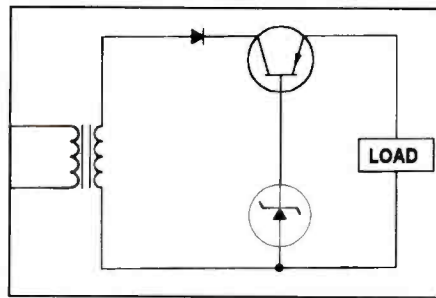

Figure 6. Use of only a zener diode will provide a degree of regulation, but the situation will be improved with the addition of a transistor, as shown here. In this configuration, the transistor acts as a sort of variable resistor.

the IC in place of the voltage across R104. The voltage across R104 is only used during the start-up operation.

After all of the energy is depleted in the secondary windings, the voltage at pin 8 of T101 starts to decay toward zero. This decreasing voltage is applied through R105 to pin 8 of the IC. The purpose of this input to the IC is to detect when a zero occurs at that point in the circuit. When this voltage goes through zero, that tells the IC to output a signal at its pin 5, turning the MOSFET back on, thus starting another cycle. Current will again start increasing through Q101 and the voltage on pin 2 of the IC starts increasing again.

Some method is needed so that once the power supply is operating in the steady-state condition, the output voltages can be regulated so that they are relatively constant regardless of line or load variations. The feedback input of U14101, pin 1, provides the capability for regulation.

Let's go back to the feedback winding of T101, the winding between pins 8 and 9. This winding serves three functions. We've discussed two of these functions already:

- it provides power to the IC, and
- it serves as the zero-crossing input to the IC.

The third function of this winding is to provide voltage feedback information from the circuits on the secondary side back to the IC.

The transformer is physically constructed such that the feedback winding is tightly coupled to the Reg B+ winding on the secondary. Because of this tight coupling, the voltage across Nf closely tracks voltage fluctuations on the secondary side of the supply. This voltage is rectified by CR102 and filtered by C147, and then applied to a precision voltage divider, con-

sisting of R147 and R149. The output of the divider is connected to pin 1 of the U14101. If this voltage exceeds 400mV, the IC shuts off the drive to the MOSFET. Through this method, the signal from pin 5 of the IC, which drives the MOSFET, is manipulated so that the voltage at pin 1 of the IC is maintained at 400mV. The voltage divider is adjusted so that this 400mV corresponds to the required Reg B+ (approximately 140Vdc).

As has been described here, there are

two conditions that cause IC14101 to turn off the MOSFET:

- when the voltage on pin 1 exceeds 400mV and
- when the voltage on pin 2 (the primary current sensing pin) exceeds 3V. Pin 1 senses the output voltage, while pin 2 limits the maximum output current. If the output load increases, then more energy must be stored in the primary winding of the transformer and transferred to the secondary. This requires that the MOSFET be turned on longer. If the MOSFET is on too long, C146, connected to pin 2 charges to above 3V and shuts off the drive to the MOSFET. This is a form of overcurrent protection.

Some of the other components

An understanding of the operation of this power supply will be enhanced if you have an idea of what some of the other components on the primary side do. Have a look at the upper left side of Figure 8. R145 and R122 form a voltage divider that operates on the raw B+ voltage. The volt-

Don't be stupid.

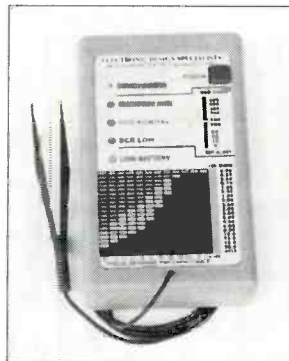

www.eds-inc.com

Smart techs know that to be productive you need to find defective components quickly. Maybe that's why 37 TV stations, General Motors, Matsushita Industrial, Sears Service, Pioneer Electronics, Panasonic Authorized Service, and thousands more independent service technicians have chosen the **CapAnalyzer 88** over all of the other capacitor checkers. Check www.eds-inc.com/88users.html for actual **CapAnalyzer** users' comments as they compare their **CapAnalyzer** to the "wizards" and "z-meters" they already own. They all prefer the **CapAnalyzer 88** because it does what you expect it to do: check

electrolytic capacitors, in-circuit, with 100% accuracy. Period. No unsoldering to check out-of-circuit, no mistaking a shorted or leaky cap as good, as other "ESR" meters do, no guessing about whether a value is good or bad. With our exclusive three-color chart right on the front panel, auto-discharge, multi-beep alert, and one-handed tweezer test probe, even your pet monkey could find defective caps in that problem TV, monitor or VCR in a few seconds. 55% of sales of **CapAnalyzers** are from recommendations by other **CapAnalyzer** owners, and 9% of sales are from previous customers buying a second unit. So get smart and buy one for yourself. It's only \$179. With our exclusive 60-day satisfaction-or-money-back guarantee, you risk nothing. Your only problem will be running out of work as you take care of all of those "dogs" that you've been sitting on. We're EDS. We make test equipment designed to make you money. Available at your distributor now. **561-487-6103**

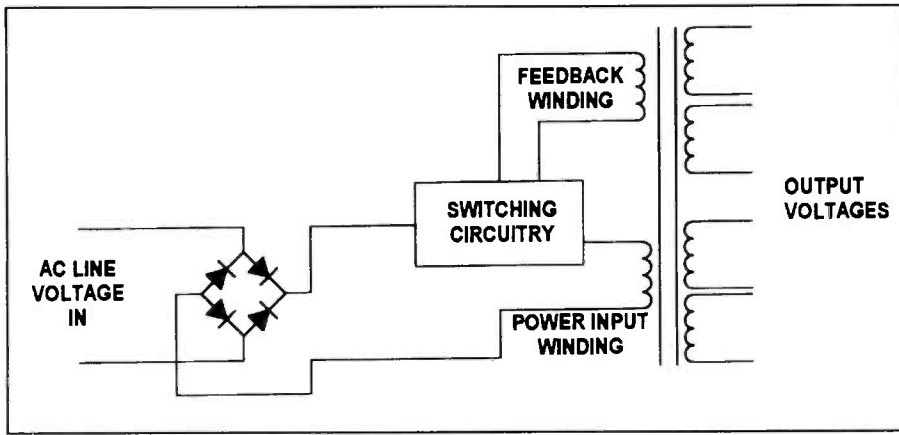

Figure 7. In this circuit, the bridge rectifier rectifies the 120V, 60Hz, line voltage. The rectified voltage is smoothed by capacitor C1, and connected to the primary winding of the transformer through the switching circuits. The feedback winding, on the primary side of the power supply circuit, is coupled to the secondary winding. The feedback signal is connected to inputs that are used to control the switching of the switching circuits.

age that drops across R122 is applied to pin 3 of U14101. This forms a “voltage in” monitor that will shut the power supply down if the line voltage becomes too low. If the line voltage drops to such an extent that the voltage at pin 3 falls below approximately 1V, the supply shuts down.

The R/C/diode network across pins 3 and 4 of T101 form a snubber network to help dampen any ringing that might occur when Q101 turns on and off.

Operation of the supply secondary

A glance at the secondary side of the power supply reveals that it provides power at several different voltages to a number of circuits: +140V, +16V, -12V, and the audio supply which will be any of a number of different voltages depending on which one of several audio systems is in the unit. The secondary power supplies provide power as long as there is ac power to the set. Each of these voltages is derived from its own individual winding of the transformer, through its own rectifier/filter combination.

Besides providing 140V to the circuit that requires it, the 140V supply voltage is also fed to a resistor/zener diode circuit, that creates a 33V supply output voltage.

Two other supply output modules

At the lower part of Figure 8, you will find U14701, the main regulator. This IC provides a +5V run supply voltage and a +12V run supply voltage, both of which are switchable. Both of these voltages are derived from the +16V supply voltage.

The 16V is supplied directly to U14701

pin 1. The voltage at this input is used to generate the +12V.

The voltage at pin 2 that is used to generate the +5V supply voltage output from U14701 originates at the +16V supply voltage, but is reduced to a lower value by passing it through a resistor. This reduces the 16V to a lower value in order to reduce the amount of power dissipated by the IC.

The outputs of U14701 are filtered before being applied to the appropriate circuits. These outputs from pins 6 and 7 of the IC can be switched on or off by a TTL control signal from the system control circuit [notice the callout “RUN/STBY (from Sys Ctl U13101-19)]. The outputs of the IC can be turned off by pulling pin 3 low.

IC 27905 is the same type of regulator as U14701, but provides the supplies for the FPIP module.

Troubleshooting

If a malfunction occurs in one of these sets and it is traceable to the switching power supply, you may be able to quickly isolate the cause of the problem using the DMM to make a few resistance and voltage measurements. If the symptoms lead you to believe that the main supply is not running, check to see if there is raw B+. An easy place to look for this voltage is across the terminals of C208. You should measure about 150V across this capacitor.

Waveform on pin 6 of IC U14101

If there is raw B+, check pin 6 of U14101 with an oscilloscope. If you see a waveform varying between 4.5V and 12V,

you’ve found the problem. This waveform does not exist under normal operating conditions. It occurs when the V_{CC} voltage on pin 6 of the IC is not high enough to allow the IC to operate. As C127 charges through R104, the voltage on pin 6 of U1401 will begin to rise, but will then fall when U14101 attempts to turn on.

Under the condition described here, U14101 will begin to generate pulses at its pin 5 to turn on Q101. If the power supply doesn’t start, the voltage on pin 6 will start to decay, and the IC will turn off. This process then repeats itself over and over, resulting in the oscillation on pin 6 that you saw on your scope.

The most likely cause of this malfunction is a diode, CR111 that has become open circuited. If this diode was shorted, the symptom would be different: the voltage on pin 6 would be very low, and there would not be any oscillation.

Excessive load on power supply secondary side

Another condition, and its symptom, of which technicians should be aware is the existence of a heavy load, or a short circuit somewhere in the secondary. During an excessively heavy load in the secondary, the voltage on pin 2 of U14101 will exceed 3V, which will cause the power supply to shut down in order to limit the current into the set. Once the power supply has shut down, it will try to restart itself. If the condition that caused it to shut down in the first place still exists, it will shut itself down again.

This sequence of attempted start up followed by shut down will repeat itself at intervals of approximately 1/2 second. As the power supply continues to restart itself, a large amount of current will be flowing through the primary of the transformer. These large current surges will result in an audible “chirp.” If the set won’t start up, but you hear a chirping sound as it attempts to start, suspect a short in a circuit connected to one of the secondary power supplies, such as a shorted horizontal output transistor.

If the line fuse opens

If the line fuse opens, the likely cause is something on the primary side of the power supply that has shorted. The most likely cause of this kind of problem is a shorted Q101. It handles quite a bit of cur-

Serviceing compact disc and digital video disc players

by John A. Ross

Within a fairly short time, disc technologies, such as compact discs, CD-ROMs, laser discs, and digital video discs, have grown from a wish list item to a technology that we almost take for granted. Prices for disc technologies have dropped to the point that most CD-ROM players found in personal computers are considered throw-away items. As disc technology has become common place, it has revolutionized the way that we store information; play back music; and has allowed everyone access to multimedia technologies.

A popular storage medium

The popularity of disc technologies has grown because of several significant factors. While a compact disc can hold up to 540 megabytes of data, a digital video

Ross is a technical writer and microcomputer consultant for Ft. Hays State University, Hays, KS.

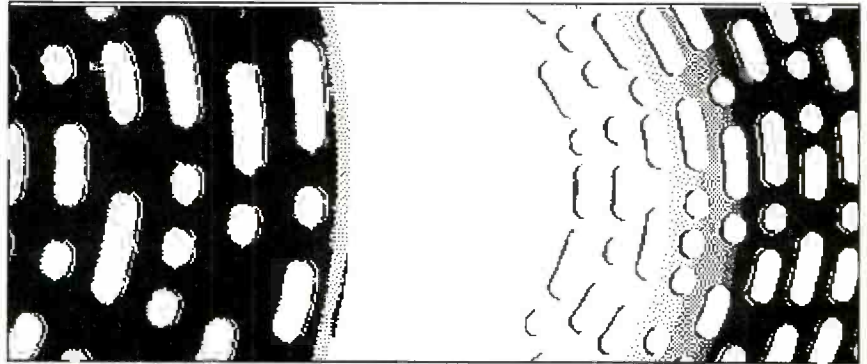

Figure 1. Data on an optical disk is encoded as indentations called pits and spaces called lands, through a stamping process. Aligned into spiral tracks, each transition from a pit to a land is a binary one, while each constant land or constant pit represents a binary zero.

disc may contain as much as 10 gigabytes of data. Despite the capability to store immense amounts of textual, graphic, audio, or other digital information, disc readers and recorders, along with the media, remain available at low costs.

Furthermore, the disc offers the consumer a very robust, removable multimedia storage medium that has a long lifetime.

The introduction of digital video disc, or DVD, technology has taken disc technologies to a new level. Because DVD

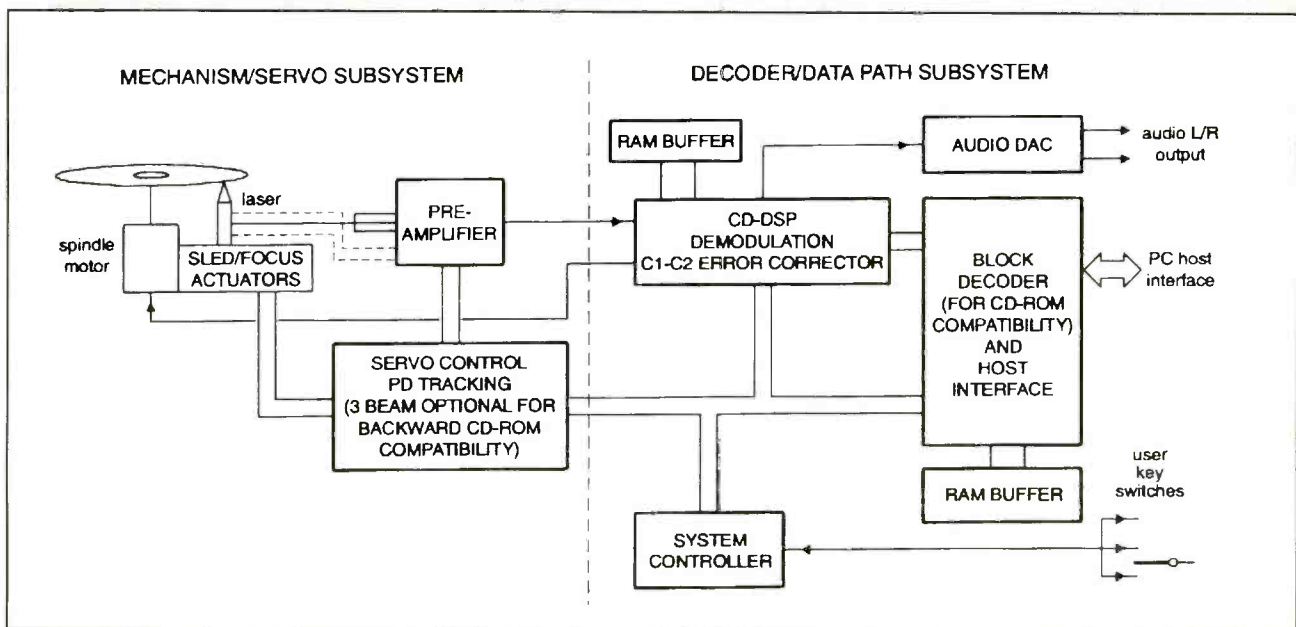

Figure 2. Block diagram of a digital video (versatile) disc player. DVDs differ from compact discs in that the density of information is increased through the use of a higher frequency laser; closer track spacing; improved encoding processes; and the use of a double-sided disc.

Table 1 - Compact disc versus digital video disc

	<u>Diameter</u>	<u>Data Capacity</u>	<u>Layers</u>
Compact Disc	120 mm	680 Megabytes	1
Digital Video Disc	120mm	4.7-10 Gigabytes	1, 2, 4

technology operates with digital media, it offers interactivity when playing movies or other formats, real-time simultaneous support of multiple languages, and the use of multiple camera angles along with parental control and other functions. The storage capability of a DVD allows the running of up to nine hours of Dolby AC-3 audio and MPEG-2 video programming.

Disc service opportunities

Although steady price decreases have accompanied the popularity of disc technologies, service opportunities remain. Many problems that occur with disc technologies have fairly easy solutions. As with VCRs, the disc players and recorders contain a mix of mechanical and electronic sub-systems. Mechanical problems involve common issues, such as dirty or misadjusted assemblies or dirty lenses. Electronic problems include tracking adjustments, servo adjustments, failed laser diodes, or bad connections.

Placing information on a disc

Compact discs, digital video discs, or laser discs contain audio and video information, parity bits for error detection, con-

trol symbols, and display information. As shown in Figure 1, the data is encoded onto the disc as indentations called pits, and spaces called lands, through a stamping process. Aligned into spiral tracks, each transition from a pit to a land or a land to a pit represents a binary one, while each constant land or constant pit represents a binary zero.

Disc player electronic systems

Figure 2 shows the block diagram of a digital video disc player. DVDs differ from compact discs in that the density of information increases through the use of a higher frequency laser; closer track spacing; improved encoding processes; and the use of a double-sided disc rather than single-sided discs. Table 1 compares the two disc formats.

All processes shown in the diagram involve the flow of clock and data signals between a microcontroller, digital signal processor, audio/video decoder, and support circuits. In addition to reading the data, the electronic system also decodes information retrieved from the disc. Decoding the information involves error correction; recovery of unrecoverable

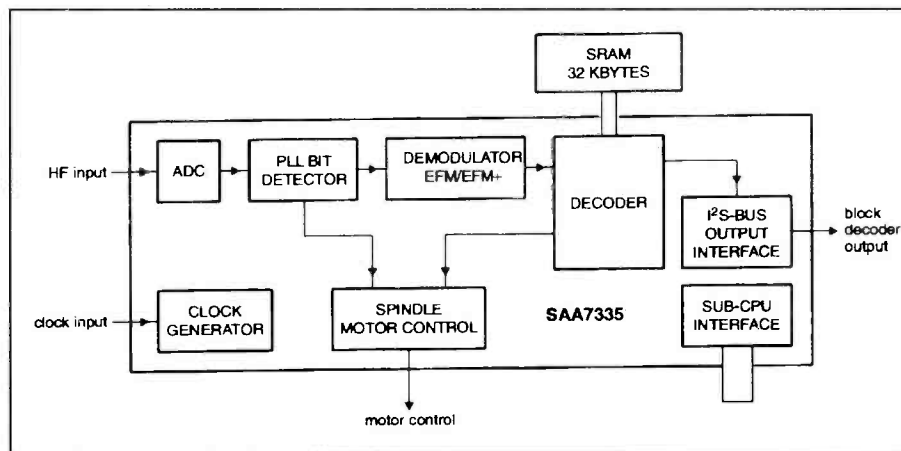

Figure 3. The DVD-DSP, a digital signal processor, translates the laser pulses back into an electrical signal. A DSP application converts analog signals to the digital domain for processing and then back to analog signals for playback or display.

Tech tips . . .

Here are a some tips from the Thomson monthly ESI CD-ROM disk for February 1999.

CTC 195, no convergence/missing convergence in menu

On the CTC195 chassis, no convergence/missing convergence in menu can be diagnosed with a few checks. At turn on, the microprocessor looks for the digicon IC on the convergence PCB. If the micro doesn't see the digicon IC, it assumes it's a direct view set. Convergence is not used in a direct view, so the micro will remove the convergence option.

1. Check V_{CC} to digicon IC, U19501. If this voltage is missing, check U19502, 5V Regulator.
2. If voltages are missing at U19502, check Convergence Power Supply. An overcurrent condition in the convergence amp circuit can cause the power supply to shut down. To check, unplug the convergence yokes and check to see if power supply is running. Plug yokes in one at a time to see which amp circuit is at fault. If power supply is still not running, troubleshoot the Convergence Power Supply.
3. Check Clock and Data lines to Digicon, U19501. If missing, troubleshoot lines to micro.
4. If Clock and Data communications are correct, check all inputs to U19501 before it is replaced. A complete convergence alignment must be done when the Digicon IC is replaced.

No video, flashing video (PTV sets only)

Projection TVs are equipped with a scan loss circuit. The purpose of this circuit is to blank out the CRTs in the event of loss of vertical or horizontal deflection. It is possible for this circuit to cause a no-video or flashing-video symptom. When checking the scan loss circuit *never defeat the scan loss unless you are sure that the deflection circuit is functioning properly.*

CTC169/CTC178/CTC188

1. Check V_{CC} to Scan Loss IC. If voltage is missing, troubleshoot the PTV Power Supply.
2. If V_{CC} is pulsating, suspect an over current problem. Start by unplugging the convergence yokes. If V_{CC} returns to normal, troubleshoot appropriate convergence amp circuit. Another possible cause is the resupply for the regulator IC not coming up. Suspect the resupply diode opening under load.
3. If V_{CC} is all right, check for loss a vertical or horizontal scan.

CTC195

Check for V_{CC} to Scan Loss IC. If V_{CC} is correct, look for loss of vertical or horizontal deflection.

The scan loss circuit can also cause a partial loss of video or a black band in the picture. If deflection circuits are operating properly, you can defeat the circuit by grounding the output of the scan loss switch transistor. Look for resistors that have increased in value and check vertical parameters in the service menu (vertical countdown).

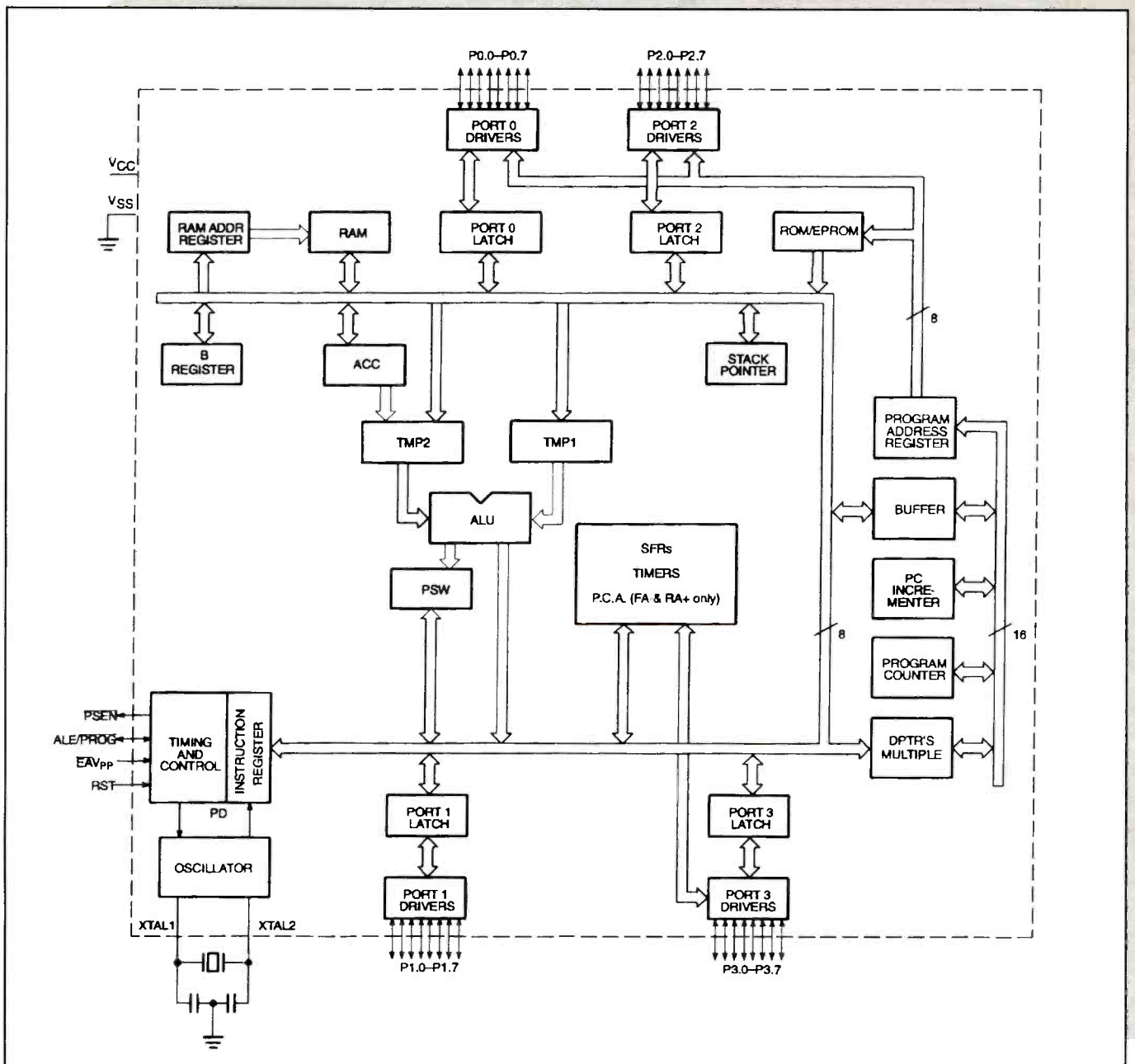

Figure 4. A microcontroller controls the status of the servo system while a digital video disc player is interpreting and initiating commands given by the user through a remote control or keypad. The microcontroller sends data to the audio/video decoder and the disc reader mechanism. In addition, the microcontroller controls parental lockout and decryption functions.

data; conversion of digital information to an analog format; and filtering. Most DVD players rely on linear power supplies.

Optical pick-up unit

The diagram begins by showing that an optical pick-up unit, or OPU, reads and retrieves data from the disc. As detailed in the October 1997 issue of **Electronic Servicing and Technology** magazine (Understanding and Troubleshooting Laser Optical Pickup Devices), modern optical pick-up units include a laser diode; optics; focus and tracking actua-

tors; and a photodiode array. Given the need for movement across the disc, the optical pick-up unit is mounted on a sled.

The varying speed of the disc motor results in the reading of the data at a constant rate. Because the disc contains spiral tracks, the motor speed decreases as the scanning moves from the beginning near the center of the disc to the end at the edge of the disc.

Reading the pits and lands

As the unit reads the disc, the amount of laser beam-produced light reflecting

from the disc varies as the beam strikes pits and lands. With this variation, the modulated and reflected light represents a radio frequency signal read by a photodiode. In CD and DVD players, an encoder converts the data into high fidelity sound. With optical storage devices, the data represents program code, text, audio or video multimedia, color photographs, or other types of digital information.

While it may seem reasonable to compare the optical pick-up unit to a phono-

(Continued on page 39)

Servicing CD (from page 26)

graph needle, the precision required for the tracking of the disc by the OPU has little comparison with the old phonograph technology. The servo systems within a CD or DVD player maintain the focus and tracking of the OPU within micrometers. All this occurs because of the minute differences in depth between pits and lands and the extremely short wavelength of the laser light emitted by the laser diode.

Interpreting the modulated beam

The laser beam travels through a prism-like beam splitter to a photodiode array. In addition, the beams travel to a lens that converts the laser beam into parallel beams; a turning mirror that reflects the laser light to the objective lens, and a set of focus/tracking actuators before reaching the disc that move the lens up, down, and side-to-side. When the laser light is reflected from the disc, servos react to the information by controlling the focus and tracking. The servo maintains the tracking of the OPU by keeping the amplitude of the reflected beams equal.

Modern optical pick-up units combine the laser diode and photodiode array into one device. With the exception of the diffraction grating and turning mirror, most manufacturers eliminate all other optical components such as the beam splitter. In addition, most units rely on an astigmatic objective lens rather than the series of lenses seen in older optical pick-up units.

The DVD-DSP

Moving back to Figure 1 and then to Figure 3, the DVD-DSP, a digital signal processor, translates the laser pulses back into an electrical signal. A DSP application converts analog signals to the digital domain for processing and then back for playback or display. With the DVD-DSP, all input signals arrive from the real world. Because of this direct connection to real world signals, the DSP must react in real time and must measure and convert signals, such as analog voice, to digital numbers for processing.

DVD microcontroller

Moving to the next point in the block diagram and then to Figure 4, a micro-

controller controls the status of the servo system while interpreting and initiating commands given by the customer through a remote control or keypad. The microcontroller sends data to the audio/video decoder and the disc reader mechanism. In addition, the microcontroller controls parental lockout and decryption functions. An imbedded microcontroller, such as that utilized in a digital video disc, is a highly integrated chip that contains a central processing unit, random-access memory, some form of read-only memory, input/output ports, and timers. Unlike a microprocessor, the microcontroller is dedicated to the specific task of controlling DVD functions.

DVD audio/video decoder

Digital video disc players operate with MPEG-2 audio and video compression, as well as Dolby AC-3 compressed audio signals. Referring back to Figure 1 and then to Figure 5, the digital audio/video decoder decompresses the compressed audio and video information and then converts the digitized data into analog-format audio and video signals.

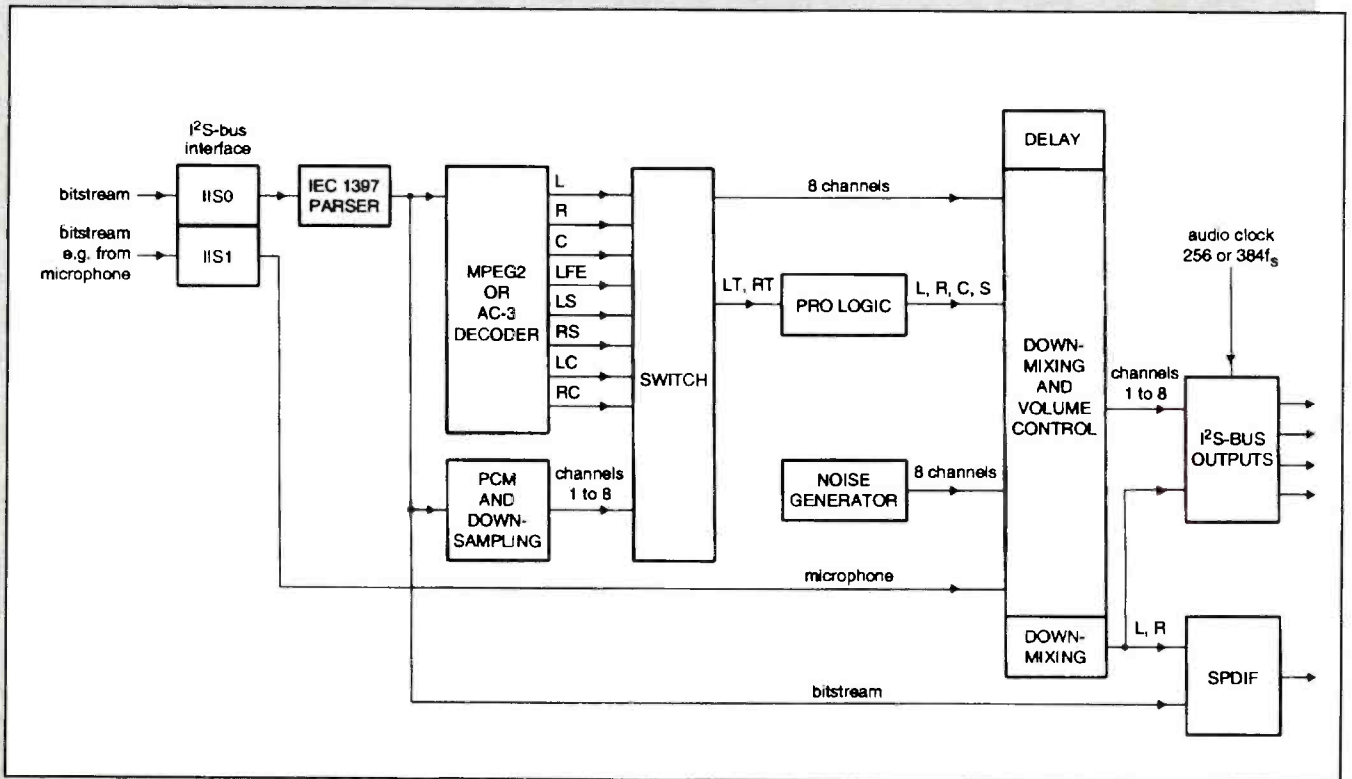

Figure 5. The digital audio/video decoder decompresses the compressed audio and video information and then converts the digitized data into analog-format audio and video signals. Moreover, the audio/video decoder also interfaces with either an on-screen display or LED display.

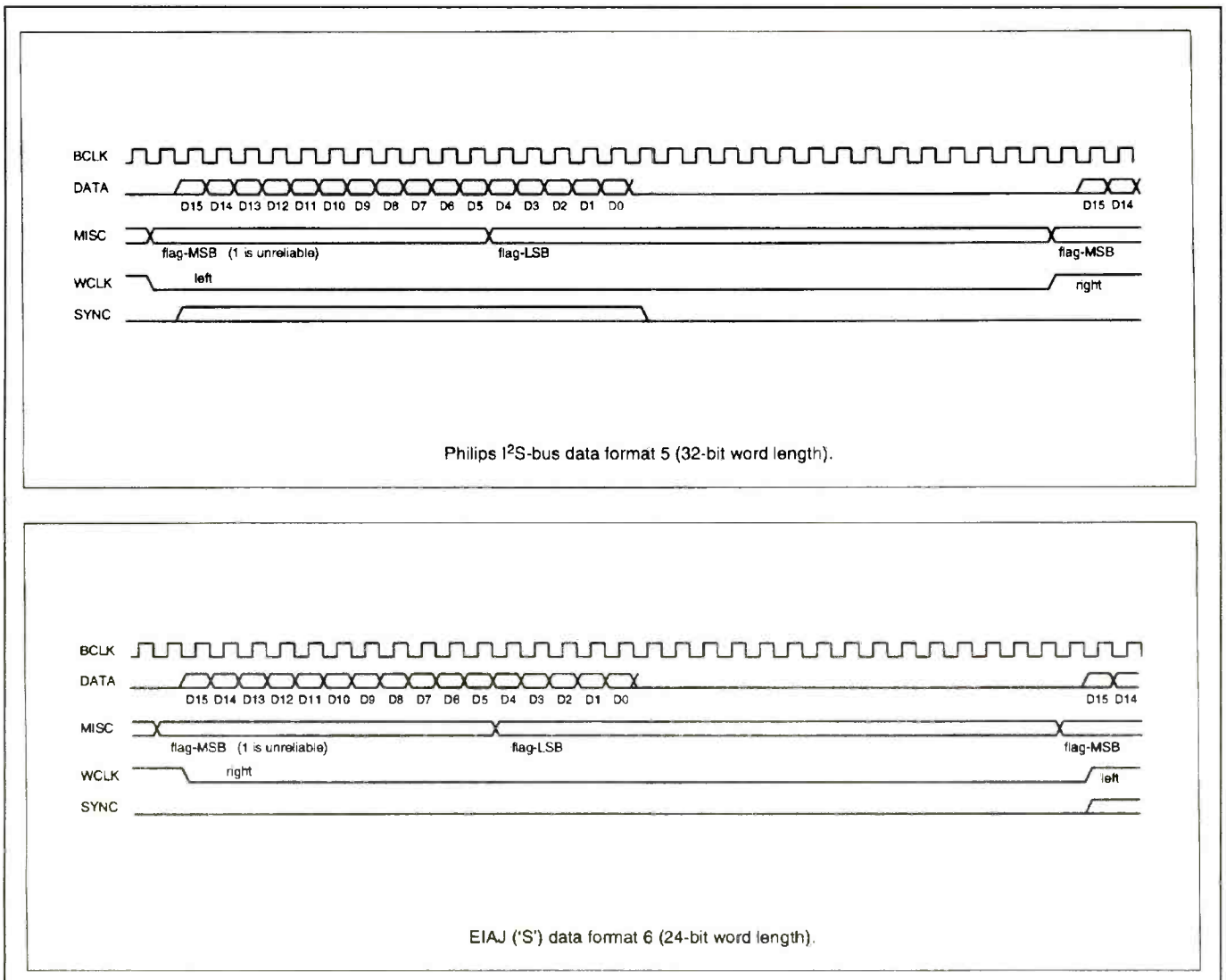

Figure 6. The DVD data waveform.

Moreover, the audio/video decoder also interfaces with either an on-screen display or LED display.

Digital video disc data

Data read from the disc takes the form of 588 frames. These words are combined into 588 bit frames. Each frame contains 24 bytes of audio data and 8 bits of information used to encode information such as the time, track, or index. Each data track on a disc consists of 98 consecutive frames that make up one block of data. With each block containing 2352 bytes of data, the electronic system can read 75 blocks per second.

The audio/video decoder decodes the data from 14 channel bits into eight-bit data bytes. Each frame equals 24 data bytes and eight error correction bytes. In

addition, each eight-bit control and display byte in the individual frame carries sub-coding channels that consist of 98 sub-coding bytes. Each sub-coding channel has a designation that ranges from P through W. In turn, each sub-coding channel is also encoded one bit for each channel in a control and display byte. While Channel P functions as a simple music track separator, channel Q encodes information, such as the track number, track type, and location and provides a table of contents.

DVD technology relies on two stages of error correction. At the first stage, a Cross Interleave Reed-Solomon error correction decoder uses four of the error correction bytes to check for correctable errors that could occur during the encoding/decoding process. With interleaving, the 24 data

bytes and remaining error correction bytes pass through a set of delay circuits before going through another Reed-Solomon decoder. Each delay circuit causes the interleaving of the data so that long error bursts spread through multiple passes of the second decoder.

The second decoder relies on the remaining error correction bytes to correct any other errors that may occur in the data bytes. Within the second decoder, interpolation reconstructs bad data that is surrounded by good data. If large amounts of data test as bad, the second decoder signals the microcontroller and the audio is muted for a fraction of a second. After the data bytes exit from the second error correction stage, de-interleaving restores the data bytes to the correct order. Figure 6 shows the waveforms for the data bytes.

*Table Two - Compact disc and digital video disc player:
Problem symptoms and solutions*

<u>Symptom</u>	<u>Cause</u>	<u>Solution</u>
Weak or missing RF Signal	Bad Photodiode	Replace OPU/Check supply voltages
Weak or missing RF Signal	Bad Laser Diode	Replace OPU
No Audio or Video	Dirty Turning Mirror	Clean Mirror
No Audio or Video	Dirty or Scratched Lens	Clean Lens/Replace OPU
No Audio or Video Signal	Broken OPU data cable	Replace data cable
OPU will not track properly	Bad Focus Actuator Bad Tracking Actuator	Replace Actuator
Inconsistent Speed Door Won't Open or Disc Won't Load	Dirty mechanism Broken or Worn Gears	Clean slide assembly Replace drive assembly
	Dirty drawer switch Shorted Motor	Clean switch assembly Replace loading motor
Disc has erratic speed	Dirty or Dry Spindle	Clean and lubricate spindle.
OPU will not track properly	Dirty sled track Damaged motor	Clean sled assembly Replace motor

Disc mechanical systems

A mechanical system consisting of a spindle or turntable, clamper, the servo assembly, the tracking assembly controls the focus, tracking, and retrieval rate of the disc. The mechanical system also includes the OPU sled and sled motor, as well as the loading drawer.

Spindle, spindle table, and spindle motor

Manufacturers refer to the platform that holds the disc as the spindle, spindle table, or spindle platter. The spindle automatically centers the disc and spins at a constant rate because of the spindle motor. Depending on the cost of the player, a spindle motor may be either a brush-type or brushless dc motor. Most manufacturers rely on direct-drive spindle/spindle motor combinations. The clamper, a magnet found on the opposite side of the disc from the spindle, maintains the position of the disc on the spindle.

Sled and sled motor

As mentioned, the optical pick-up unit

mounts onto a sled that allows the OPU to move across the disc. Supported on guide rails, the sled moves according to commands from the microcontroller and may either allow the optical pickup unit to track completely across the disc for normal play or may move the OPU to a specific position over the disc when in the search mode. Most manufacturers rely on conventional direct drive dc motors to push the sled.

Solving disc technology problems

Common sense tells us that compact disc and digital video disc players can experience a combination of mechanical and electronic problems. Mechanical problems result from dirty and dry slides; the aging of rubber parts; or a dirty lens and appear as seek failures, noise, or incorrect tracking. Many electronic system problems result from bad connections on the main circuit board or breaks within the flexible cables that run from the OPU to the remainder of the player. Table 2 lists problems that can occur and shows possible solutions. ■

ES&T READER SURVEY

**It's a mini survey
about you.**

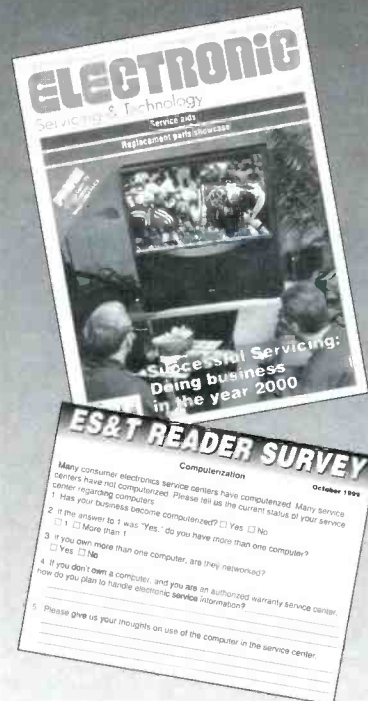

Bound into this issue is the ES&T Reader Survey card.

We would like to hear about the problems you face, the opportunities you see and the equipment you use during the course of your work day.

The postage is paid. All you have to do is fill it out and mail it.

What could be easier?

**Please fill yours out
and mail it today.**

Literature

Adapter catalog

Emulation Technology announces the release of its 1999 Interconnect Solutions catalog.

The 212-page catalog enables engineers to quickly and easily locate adapters and accessories for their design under test, and can be used as an immediate source book for a wide range of IC packages and chip types. The catalog includes more than 200 product photos along with information on more than 4,000 products, including emulator tools, logic analyzer/scope adapters, field-configurable adapters, and custom adapters.

The catalog provides three levels of adapter solutions: Off-the-Shelf adapters are designed for most chip/packages; Field-Con-



figurible adapters, so the designers can create their own adapter on the spot; and Custom adapters that the company can design if a designer has a special custom requirement. The reference catalog has a section on "Choosing the Right Adapter," which gives drawings of various package types, along with a "view" of each. Also included is a complete section of footprint drawings which detail

hundreds of product footprints for the following IC packages: BGA, PGA, HGA, PLCC, LCC, JLCC, SOIC, SOJ, SSOP, TSOP, PQFP, Flatpacks, and Production Sockets.

Emulation Technology, 2344 Walsh Avenue, Building F, Santa Clara, CA 95051-1301. Phone: 408-982-0660. Fax: 408-982-0664.

Circle (90) on Reply Card

Product catalog

B&K Precision Corporation announces the availability of its new Spring 1999 New Product Catalog. The 16-page full-color catalog supplement is available free of charge and features over 25 of B&K Precision's new products including: IC testers, programmable power supplies, and video monitor testers, as well as the firm's most popular test instruments and accessories. The catalog will be a useful source document by electronic and electrical field service, depot service, and engineering/R&D personnel.

The catalog opens with the introduction of the company's newest handheld IC testers; the Model 570 linear IC tester, and the Model 575 digital IC tester. The two handheld, battery-powered IC testers feature extensive built-in libraries and are ideal for use in the field or in the lab. Two new video monitor testers

are introduced; the Model 1275 handheld, battery-powered video monitor tester and the Model 1280A bench-top tester, both of which can be used to test both IBM compatible personal computer monitors and Mac monitors. The Model 1280A can also be used for multiple monitor burn-in and as display generator.

Also offered is an expanding range of function generators. The "New for '99" Model 4070 function & arbitrary waveform generator, a single source signal generator combining the latest DSP and DSS tech-

nologies, offers a number of operating modes and provides a versatile cost-effective signal source. Descriptions and pricing for other function generators, such as the Model 4011 4MHz function generator with digital display and the Model 4040 20MHz sweep/function generator with frequency counter, are also covered.

B&K Precision Corporation, 1031 Segovia Circle, Placentia, CA 92870-7137. Phone: 714-237-9220, Fax: 714-237-9214. Website: www.bkprecision.com

Circle (91) on Reply Card

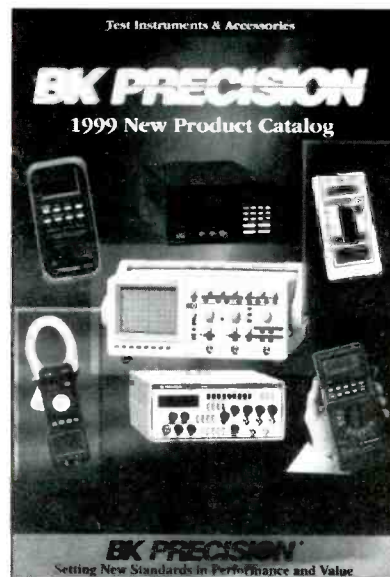

Controlling EMI in transformers and switch-mode power supplies

Signal Transformer Co., Inc., has released a new application note entitled "Controlling EMI in Transformers And Switch-Mode Power Supplies" that provides insightful information on ensuring performance in applications where there may be interference.

The application note presents design methods that can be employed to prevent uncontrolled electromagnetic interference (EMI) produced by transformers and switch-mode power supplies from hindering communications systems and interfering with the proper operation of sensitive electronic equipment. The importance of the proper positioning of a transformer within a circuit or system is discussed, as is the effect the transformer's core size and number of turns it has on EMI.

An explanation of how a Faraday shield can be used to minimize radiated emissions from primary-winding voltage spikes being transmitted to the secondary windings is presented. Also included is a look at how the configuration of transformers and inductors plays a role in controlling EMI.

Signal Transformer Co., Inc., 500 Bayview Avenue, Inwood, NY 11096. Phone: 516-239-5777, Fax: 516-239-7208. Website: www.signaltransformer.com

Circle (92) on Reply Card

Application note

An application note titled "Select the Proper Transformer According to International Standards" is available from Signal Transformer Co., Inc., an operating unit of Insilco.

The application note addresses the importance of understanding the various international standards that have been established for all aspects and parts of an electronic product, including the power transformer. It also details numerous standards from Underwriters Laboratories (UL) and discusses the types of transformers that each standard covers. Standards established in Canada by the Canadian Standards Association (CSA), in Europe by the International Electrotechnical Commission (IEC), and in Germany by the Verband Deutscher Elektrotechniker (VDE) are also discussed. A reference chart of international standards for over 65 countries is provided to use as easy reference.

The company offers an extensive line of magnetic devices including standard and custom 50/60 Hz transformers, high frequency planar transformers, powdered iron toroidal inductors, and ferrite drum core inductors.

Signal Transformer Co., Inc., 500 Bayview Avenue, Inwood, NY 11096, Phone: 516-239-5777, Fax: 516-239-7208, Website: www.signaltransformer.com

Circle (93) on Reply Card

MRO catalog

Electronic component distributor Richardson Electronics, Ltd. announced the availability of a new 256-page catalog for industrial maintenance repair operations (MRO). The catalog, which contains more than 6,000 items, features key product characteristics, product line drawings, and pricing to help expedite the product selection process.

Major product categories highlighted in the catalog are electron tubes, audio/sound products, cabinets and enclosures, capacitors, generators, power supplies and microwave heads, impeders, industrial display products, power conversion products, and security products. NEC flat panel monitors, Hammond Manufacturing cabinets and enclosures, Powerex diode modules, as well as Amperex and CPI-EIMAC power grid tubes, are among the new or hot products featured in the comprehensive catalog.



Richardson Electronics, 40W267 Keslinger Road, P.O. Box 393, LaFox, IL 60147-0393, Phone: 630-208-2200, Fax: 630-208-2550, E-mail: info@rellrom.com, Website: www.rell.com

Circle (94) on Reply Card

Guide to communications wiring

Cable University, the cabling installation training program, has published a new free booklet on communications wiring called *Uncle Ted's Guide to Communications Wiring*. This booklet was written to introduce the concepts of communications wiring, structured cabling, and the installation of networks.

The guide follows the format of the organization's other guide, *Lennie Lightwave's Guide to Fiber Optic Installation*. Both are simple, easily-understood explanations of the technology, jargon, components, and installation of communications cabling for the novice.

Cable University, 151 Mystic Avenue, Medford, MA 02155-4615, Phone: 781-396-6155, Fax: 781-396-6395, E-mail: info@cableu.net, Website: www.CableU.net

Circle (9) on Reply Card

KVM switching devices catalog

Network Technologies Inc. announces the availability of its new catalog detailing a complete range of splitters, switches, and cabling for PS/2, Sun, and Mac systems. The company presents a wide range of solutions for enterprise network applications, multi-platform environments, instructional environments, and graphic and multimedia studios. The catalog's six color-coded sections include:

- Keyboard/Video/Mouse (KVM) Switches, allow one keyboard, mouse, and monitor to control up to 128 computers. Facilitates cross-platform access and maximizes efficient use of equipment by eliminating redundant and costly monitors, keyboards, and mice.
- Video Splitters simultaneously display the same high-resolution image on up to 100 monitors — for presentations or information display in trading centers.
- Keyboard/Video/Mouse (KVM) Splitters allow up to four keyboards, monitors, and mice to be connected to the same computer. LAN managers can update and maintain a file server from an office, warehouse, or shop floor.
- KVM Classroom Systems for schools and corporate training centers. The new OSD (On Screen Display) capable module interface puts on-screen control of up to 32 students' keyboards, monitors, and mice at the instructor's fingertips. Maximizes learning by enabling the teacher to broadcast his screen to the entire class, observe students' screens, or blank screens and disable keyboards and mice to focus attention.
- Video Only Switches share one monitor among multiple computers, allowing one user to utilize more than one CPU or platform. Video Matrix Switches switch many computers' outputs among multiple monitors — ideal for classrooms, boardrooms, and presentations.
- Cabling for keyboards, video, and mice provide connectivity at 1600 x 1200 resolutions with no loss of signal. NTI's broad line of cables, adapters, and boosters present a solution for every need, according to the company.

Network Technologies, Inc., 1275 Danner Drive, Aurora, OH 44202-8054, Phone: 800-742-8324, Fax: 330-562-1999, E-mail: sales@networktechinc.com, Website: <http://www.networktechinc.com>

Circle (95) on Reply Card



Installing a mini-dish satellite system

by Jim Van Laarhoven

When the first TV satellite systems became available to the consumer, they were seen as somewhat of a novelty, due mostly to the high initial cost. Here and there you would see a large dish in someone's backyard and wonder if you should take the plunge and install one like they did. Once the mini-dish systems came out, the decision became much easier for the consumer. The cost of this kind of satellite system to install is very close to the cost of a standard cable installation. In addition, with the dish measuring only 18 inches in diameter, space is generally not a problem. Monthly satellite bills are competitive with the cost of cable, so there has been a trend towards the use of Digital Satellite Systems.

called a high-power Ku-band (microwave) or Direct Broadcast Satellite (DBS) band. Other types of TV satellites normally transmit on frequencies from 3.7GHz to 4.2GHz and mostly in C-band. This type of system is also known as Fixed Satellite Service (FSS) and is more likely to experience interference problems from outside sources than the high-power Ku-band satellites.

The two Ku-band satellites transmit microwave signals that converge with each other near the earth, however; the mini-dish on the ground is actually pointed at the space exactly between them. It is odd to discover that the dish does not point directly at the satellites to receive the signals. This is also the reason the dish has to be accurately positioned. It needs

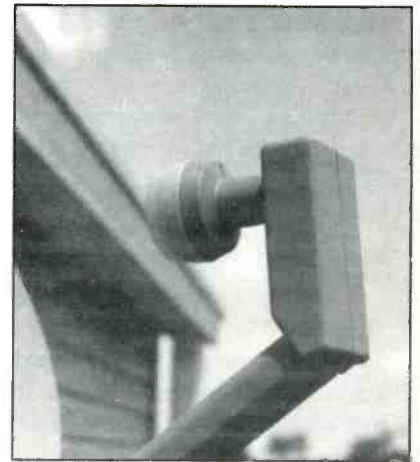

Figure 1. The 18-inch satellite dish is oval shaped to reflect the microwaves to the 22.5 degree offset of the low noise block converter (LNB) located at the end of the arm.

Operation of the digital satellite system

Before describing a typical satellite system installation, this article will provide an explanation of the operation of the Digital Satellite System. This may be helpful during the actual install and possibly for troubleshooting afterwards, should it become necessary.

The satellite

Let's start with the satellites themselves. There are in reality two digital TV satellites in geostationary orbit (22,300 miles out, circling the equator) that transmit to the earth. They are positioned 0.5 degrees apart and the center point between them is at 101 degrees west longitude. These two satellites send a 12.2GHz to 12.7GHz signal using circular polarization. This is customarily

Jim Van Laarhoven is an independent technician and consultant for computer based lighting.

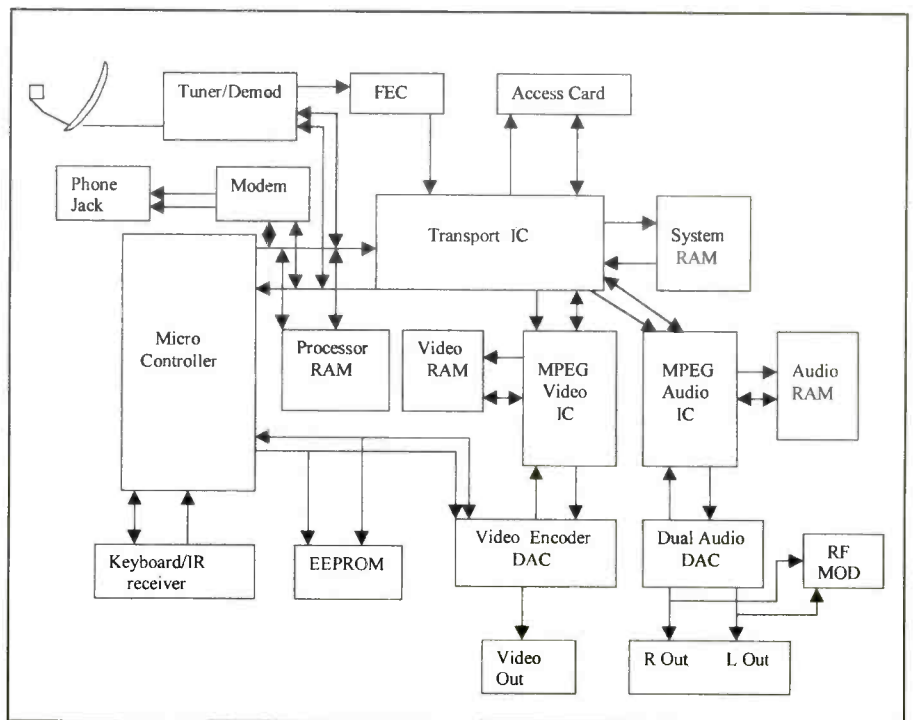

Figure 2. Once the signal from the satellite arrives at the receiver, the receiver demodulates the signal into a digital data stream.

to collect the converging microwave signals of both satellites.

The output signals from the two satellites originate at an uplink site on earth. The microwaves are collected and converted to the Ku-band frequencies by the satellites as they receive them. The signals are then amplified and sent to the satellite's transmitting antenna and subsequently sent to the earth. This transmitter/receiver is known as a transponder. There are 16 transponders per satellite. Using multiplexing and data compression, these two satellites can transmit over 200 channels.

The satellite reception system

The 18-inch satellite dish is oval shaped to reflect the microwaves to the 22.5 degree offset of the low noise block converter (LNB) located at the end of the arm (Figure 1). This offset is critical because if the LNB was centered, it would block most of the signal transmission from the satellites. The LNB converts the incoming 12.2GHz to 12.7GHz signal to a 950Mhz to 1450Mhz signal and sends it to the receiver via a coaxial cable. This lower frequency is needed because the receiver circuitry is not designed to operate at microwave frequencies (not to mention the limits of the coaxial cable).

Once the signal arrives at the receiver, the receiver demodulates the signal into a digital data stream (Figure 2). This data stream will then go to the FEC (forward error correction) circuitry, which will verify and correct errors that might have been introduced into the signal since it left the uplink site. This signal is then sent to a transport IC which processes it and then sends it to the decoders. The transport IC also uses keys from the access card (Figure 3) to descramble the data.

The decoders used in this system are known as MPEG-type (Moving Picture Experts Group), which is an international standard. An MPEG IC decodes the video and sends it to an encoder that changes the digital signal into analog video. Another MPEG IC then decodes the audio and sends it to a Digital to Analog Converter (DAC). The right and left audio channel data are thereupon separated and converted to stereo analog.

Signal compression

The interesting factor in this MPEG compression procedure is how much data

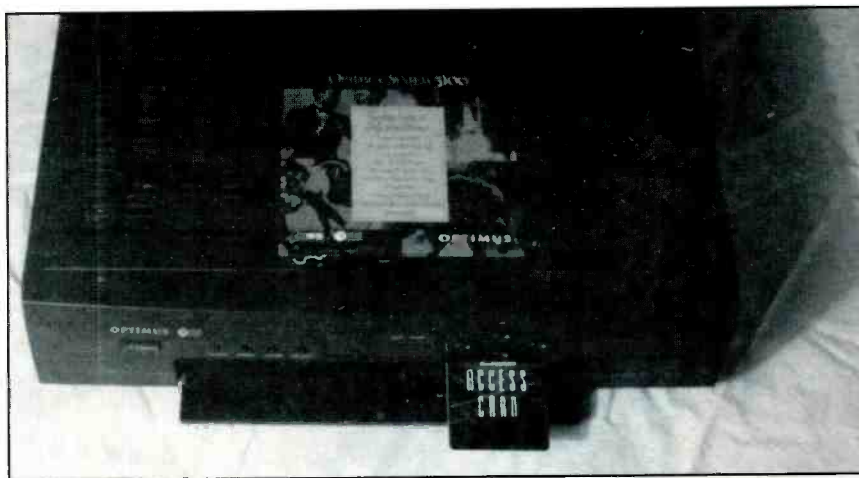

Figure 3. The transport IC also uses keys from the access card to descramble the data.

is actually sent from the uplink site. For example: you are watching a movie on your satellite system and in the scene there is a car that is standing still, but the people in front of it are moving around. As the scene unfolds, the uplink site sends only the data needed to describe changes in the picture. It does not have to keep sending the picture of the car once the first car data has been sent. It only needs to send more data when the people start to move. This reduces the video data that has to be sent from hundreds of megabits per second to about 3Mbps to 6Mbps.

Determining the latitude and longitude of the site

The first step in the install is to find out what the local latitude and longitude are at the site of the satellite dish. In the self-installer manual that is supplied with the system, you will notice a section that shows a map of the United States. This map shows the latitude and longitude lines overlaid across the U.S. (Figure 4) We will use a hypothetical installation location of Los Angeles, CA, for our example. Los Angeles is located at an approximate latitude of 35 degrees and longitude of 120 degrees. A quick check with the supplied chart tells us that the azimuth of this location to the center between the two satellites is 139 degrees at an elevation of 45 degrees (different locations will have different azimuths and elevations). Use a magnetic compass to see if the heading of 139 degrees allows a clear unobstructed view from where you would like to mount the dish. In addition,

consider that the dish will point up at a 45-degree angle. It may be necessary to mount it on a sturdy pole so that trees and buildings will not disturb the microwave path. It is also important that wherever you locate the dish, it should be mounted to something that cannot shift or be moved easily.

Installing the dish

The satellite receiving dish antenna described in this article is installed on the side of a house (Figure 5).

To begin the installation, secure the foot and mast to the side of the house with the hardware included in the installation kit. Place a bubble level on the mast where the dish will be attached and adjust the mast until it is at 90 degrees with reference to the earth. Attach the LNB support arm to the dish and then slide the support arm onto the tubular mast. Near the clamp of the LNB support arm is an adjustment for the elevation. Tilt the dish assembly until the pointer is lined up on the 45-degree mark, then tighten (Figure 6).

The next step is to aim the dish as close to 139 degrees as possible. This is accomplished by holding the compass while moving the dish from side to side until the LNB support arm is pointing at magnetic 139 degrees. You will fine-tune this directional adjustment after the hardware installation is complete.

Running the cable

Running the RG-6 coaxial cables are next. The installation kit comes with one long and one short coaxial cable. The

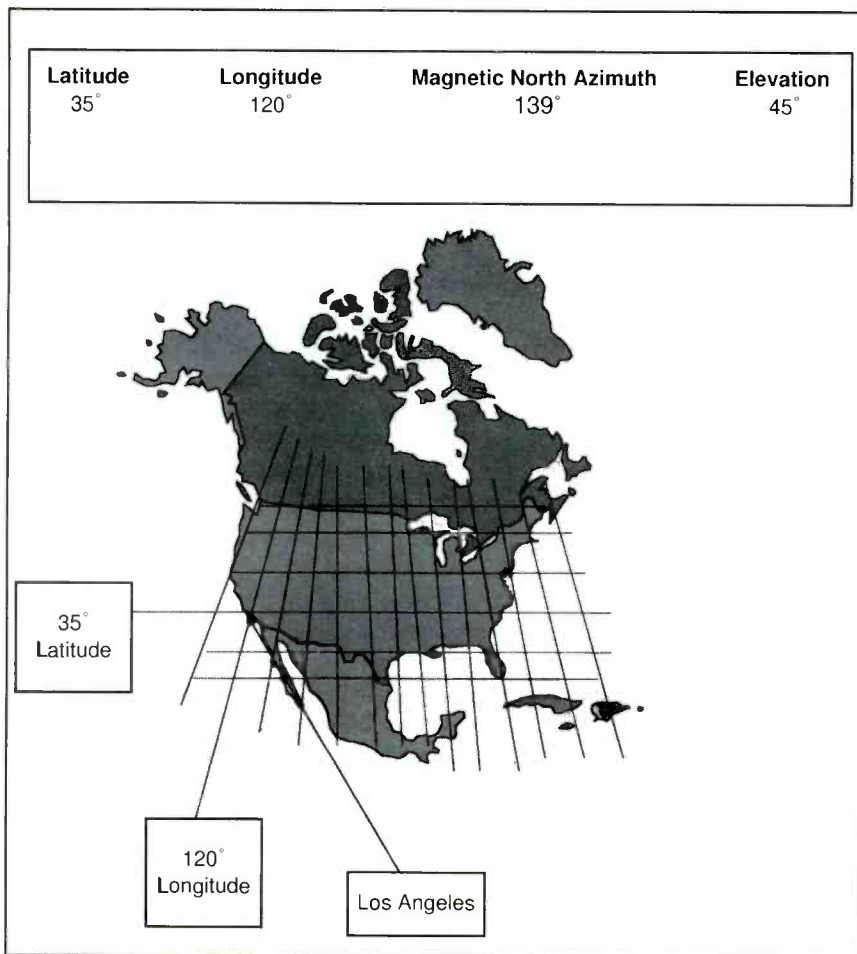

Figure 4. In the self-installer manual that is supplied with the DSS system, there's a section that shows a map of the United States. This map shows the latitude and longitude lines overlaid across the United States.

short cable will be connected from the LNB to the connector/grounding block. Separate about a foot or more of messenger (grounding) wire from the main cable and attach it to the dish grounding screw. Then slide one end through the LNB supporting arm and attach it to the LNB. It might be a good idea to apply some clear silicone to the outside of the coaxial connector to reduce corrosion in that area. The LNB is then attached by one machine screw to the LNB support arm. You may notice two coaxial connectors on the LNB. This is for a second receiver. If you do not run another cable for a second receiver, cap this off.

After running the cable down the wall, select a location to mount the connector/grounding block. Separate some more grounding wire from the main cable and connect it to the appropriate grounding screw. Leave a drip loop so moisture does not collect on the coaxial connector, and

then screw the connector to one of the coaxial fittings provided. You may have a grounding source nearby, however, driving a separate grounding rod near this block, might be a good idea. Run a wire from the grounding rod to the block.

Using the longer coaxial cable, repeat the steps for connecting to the block. Run the coaxial cable from this block to the receiver. I know it is easier to say than it is to do. Some homes make this step a real chore. Attach the coaxial cable to the *Satellite In* connector on the back of the receiver (Figure 7). Some receivers may have a grounding connector on them; if they do not, you can trim the grounding wire back so it is not in the way. Attach one more coaxial cable (not included) from the *TV Out* connector on the back of the receiver to the TV.

The next step may be optional in some systems. Run a telephone cable with a modular connector from a nearby tele-

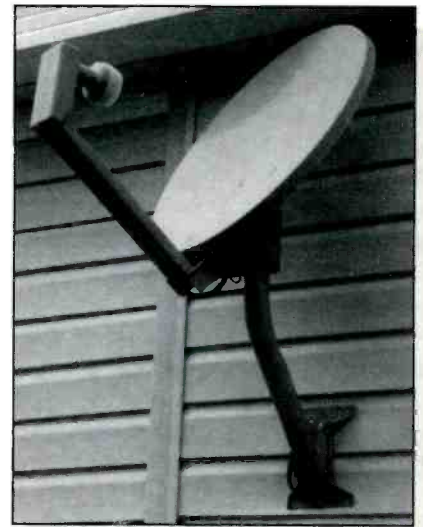

Figure 5. The satellite dish described in this article is installed on the side of a house.

phone outlet or directly from the interface if you want to use a dedicated telephone line. Plug it into the jack provided on the back of the receiver. That concludes the hardware part of this install.

Aligning the dish using on-screen menus

The on-screen menus that will be referred to in this section are from the Tandy Optimus 5100 system, so some of the steps may be different from other systems you may encounter. With the receiver access card installed and the TV and receiver turned on to channel 3 or 4, begin by pressing the *Menu* button on the satellite remote control.

Many selections will appear on the screen, however; we will pick *Options*. Again, many more selections will appear, but we will pick *Installation*. On the right-hand side of the screen, an analog meter will appear. If the needle is at zero, the dish is not collecting any signal. You may want to double-check at this point by selecting; *Enter Zip Code*, from this same screen. It will consequently give you the correct azimuth and elevation for your location. If it is the same information you gathered off the latitude-longitude chart earlier, the dish may be positioned slightly off.

It is a good idea to have a helper at this point. Have your helper call out signal strengths from the analog meter as you manually rotate the dish from outside. You want signal strengths over 70, preferably in the 90s range, if that is possible.

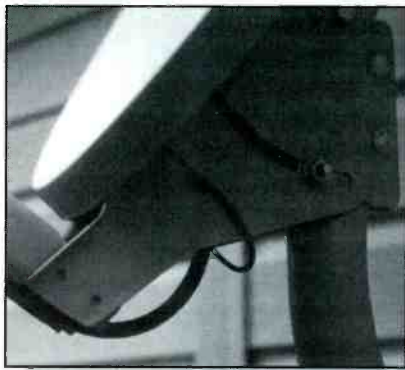

Figure 6. Near the clamp of the LNB support arm is an adjustment for the elevation. Tilt the dish assembly until the pointer is lined up on the 45-degree mark, then tighten.

After trial and error, you will zero in on the maximum strength that is obtainable for your area and current weather conditions. When you reach this value, tighten down on the LNB support arm clamp. Double-check the signal meter after securing the clamp to assure that the dish did not move as it was being secured. The unit is now receiving the scrambled signal from both satellites.

System tests and enabling the system

At this point, it is advisable to select *Run System Tests*, from the same screen where the analog meter is displayed. It will then test the signal, tuning, telephone connection, and the access card. If all the tests pass, push the exit button on the infrared remote. The screen will now be blank except for a channel banner at this time (this will also disappear after few moments). The next step is to write the access card number down along with the serial number of the receiver. You then

place a call to the satellite provider and give them this information and they will enable your system through the satellite system. In a few moments, you will be receiving the channels. The installation is now complete.

Troubleshooting

If any of the tests did not pass when you completed a *Run Systems Tests* from the analog meter screen, you may have to do some troubleshooting. When the signal test fails, here are some possible trouble areas that should be checked. If the dish is aligned properly and all of the connections are secure, the next step is to check dc voltage at the LNB. Remove the LNB and make sure voltage between the center conductor and the shield of the coaxial cable is between 12V and 18V. If it is not, the cable or the receiver may be defective. If the proper voltage is present, you may have a defective LNB. A spare LNB should be substituted and another *Run Systems Test* should be completed.

The tuner test verifies that the receiver is tuned to a satellite transponder. The signal strength may be showing an acceptable parameter and still fail this test if the LNB or the receiver is defective.

If the telephone test fails, verify that you have a dial tone by removing the modular plug from the back of the satellite receiver and inserting it into a standard telephone. If you have a dial tone, than the problem is most likely in the receiver.

The access card test is accomplished by the transport IC sending a code to the access card. If the card responds correctly, it will show that it passed the test. If the card is failing the test, a new card needs to

be issued from the manufacturer.

If the receiver is periodically losing its signal, it might be wise to check the dish for debris. Leaves, snow, and water can all distort the reflected microwaves on their way to the LNB and can cause signal loss. There is also something called rain fade that happens during heavy weather conditions. The image on the TV screen will freeze for a moment and then the screen will go blank, followed by a message that says the receiver is searching for the satellite signal. This problem usually corrects itself when the severe weather passes, but sometimes you may need to reset the system. On the Optimus 5100, it is recommended that you push the power button and the arrow up keys on the remote simultaneously. This will do a system reboot.

The standard life of a digital TV satellite in geostationary orbit is about twelve years. Satellites of this type were launched in the years 1989, 1993, and 1994. Scheduled future launch dates are not furnished to the public, nevertheless, it can be safely assumed that each satellite launched will offer new or expanded services to the digital satellite customer. ■

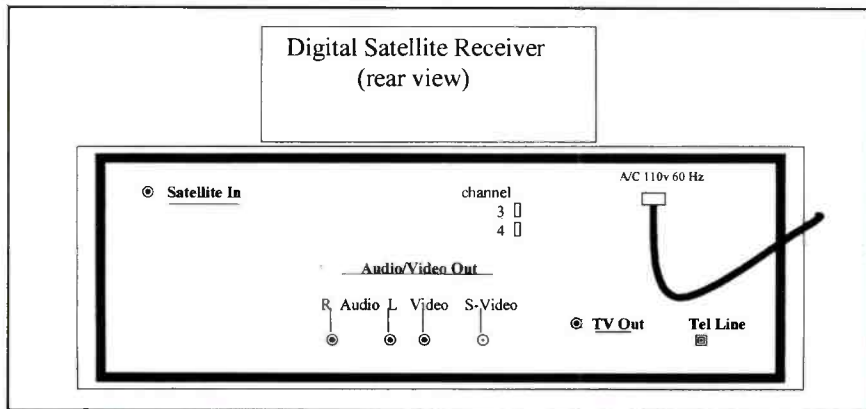

Figure 7. Attach the coaxial cable from the LNB to the *Satellite In* connector on the back of the receiver.



If you're planning a move in the near future, don't risk missing an issue of *Electronic Servicing & Technology*. Please give us 6-8 weeks notice if you're planning on changing your address. Just write in your new address below and mail this coupon.

WITH YOUR SUBSCRIPTION MAILING LABEL, to:

Electronic Servicing & Technology
25 Newbridge Road
Hicksville, NY 11801

OLD ZIP CODE: _____

Name _____

Address _____

City _____

State _____ Zip _____

Monitor servicing

by the ES&T Staff

Personal computer monitors are similar in many ways to television sets/monitors. The display is a CRT, they have power supplies, deflection circuits, and more. But these products also differ from television sets/monitors in a number of ways. This article presents an overview of VGA monitor operation, and several general and troubleshooting tips that technicians can use in dealing with computer monitors.

Overview of VGA monitor operation

Monitors contain power supplies, horizontal output circuits, vertical output circuits, control circuits, and CRT drive circuits, as do modern TV sets. The following segments provide a brief overview of these modules in a VGA monitor.

Power supply

Chopper power supplies are used in most monitors. They are relatively simple in design and usually easy to repair. Most supplies have line filtering after the ac plug, then connect to a bridge rectifier, creating a dc voltage of approximately 160V across a filtering capacitor or capacitors. On some 240V units, this dc voltage will be approximately 320V.

This dc voltage is applied to one leg of the primary winding on the power supply transformer. The second leg of this winding is connected to an FET source or transistor collector (hereafter referred to as driver). The driver drain or driver emitter is then connected to a resistor or resistors which are then connected to the negative potential of the dc voltage. The purpose of these resistors is to create a small dc reference voltage which is a representation of the current being drawn through the driver. There are times when fusible

resistors or thermistors are placed in line before or after the bridge to protect the transformer from a bad driver or faulty chopper circuitry.

Snubber circuitry consists of caps, resistors, and diodes, across the transformer primary winding and sometimes across the driver. The purpose of this snubber circuitry is to protect the driver from damage due to transient voltage spikes from the transformer.

Horizontal output

The horizontal circuitry is used to drive the flyback transformer much in the same way the power supply chopper circuitry works. Horizontal signal starts with a horizontal oscillator IC, such as an LA7850. There are caps and resistors connected to the IC to create time constants. This is done to achieve the desired frequencies. Potentiometers and dc signals can be used to alter the frequency of the oscillator. This frequency is usually amplified and sent to an FET or transistor, which is called the horizontal driver.

Most commonly, the highest voltage from the power supply is used to apply dc to one leg of the primary side of the flyback transformer. This voltage is referred to as B+. The horizontal driver is connected to the other leg of the primary winding. Many of the new monitors have an adjustable B+. The adjustable B+ is altered by frequency sensing circuitry or a microcontroller. This is done to regulate current flow through the flyback transformer during frequency changes.

The primary function of the flyback is to provide high voltage to the CRT. This voltage is typically 18 kV to 25 kV. It also provides grid voltages to the CRT. Generally, G4 is the focus grid, G2 is the screen grid, and G1 is the primary grid.

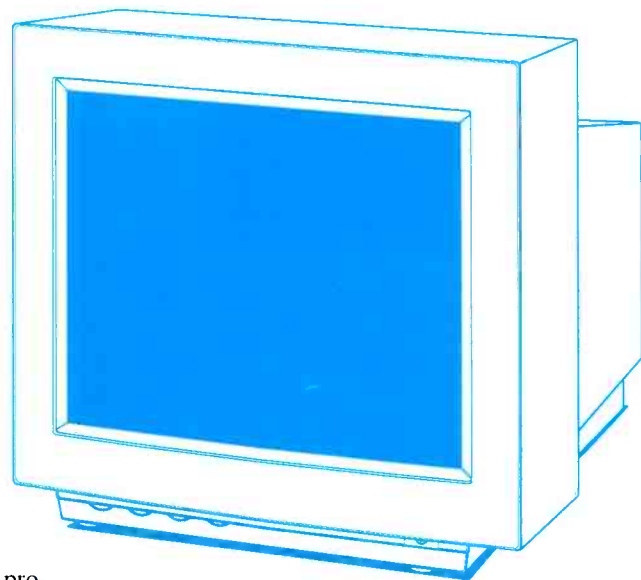

The horizontal deflection yoke is responsible for setting up the horizontal magnetic field on the CRT. This yoke is typically driven by the horizontal driver through capacitors and inductors. Additional capacitance and inductance is commonly added to adjust the drive signal on the horizontal yoke. This is accomplished by paralleling capacitors or inductors using FETs or relays.

Vertical output

The vertical circuitry is responsible for driving the vertical deflection yoke and is similar to the horizontal deflection circuitry but is not as complex. The vertical signal is generated by a vertical oscillator, such as TDA1675 or TDA1170. There are caps and resistors connected to the IC to create time constants. This is done to achieve the desired frequencies much the same way as is done in the horizontal circuitry. Potentiometers and dc signals can be used to alter the frequency of the oscillator. Most of the vertical oscillators do not require amplification to drive the yoke; they drive it directly.

Microcontroller

The microcontroller is a small computer that is contained in one IC and is programmed for one group of specific tasks. It has an oscillator and two or more ports.

This article was adapted, with permission, from segments of the book "1999 Computer Monitor Troubleshooting Tips," ISBN #0-7906-1179-1, by M.I. Technologies, Inc., published by Prompt Publications, an imprint of Howard W. Sams & Company, 2647 Waterfront Parkway E Drive, Indianapolis, IN 46214-2041. M.I. Technologies is at 310 East Peterson Rd., Troy, OH. 45373, 937-335-4560, E-mail: mit335@bright.net.

The microcontroller is used primarily to replace potentiometers, such as V-size, V-cent, H-size, H-cent, brightness, and contrast. These functions can be controlled by pushbuttons or software run by the main computer. It can also replace frequency sensing circuitry, discussed in the horizontal and vertical sections of this document, by sensing the horizontal and vertical sync pulses and sending signals to the oscillators, frequency switching FETs and relays, and adjusting the B+ circuits.

CRT driver board

The CRT driver board is responsible for amplifying low level color drive signals (i.e., red, green, blue) from the video cable and converting them from 75mV to approximately 100V. These signals are used to drive the CRT guns. The most commonly used ICs are the LM1203N and LM1207. This type of chip converts the 75mV signal into a 12V signal and adds contrast control and blanking pulses. The next stage of the amplification is usually done with transistors bringing these 12V signals to approximately 100V.

Monitor service/troubleshooting tips

Sometimes, it helps to get the troubleshooting thought process going to read the experiences of a senior technician who has taken the road before you. The following sections of this article contain suggestions, observations, and troubleshooting tips for dealing with computer monitors. Some of these ideas, suggestions, and tips apply to a number of products, and some have to do with a single brand and model.

Fan repair

Here's just a little tip on CPU and power supply fan repair. To repair one of these fans, proceed as follows:

1. Remove the fan from the heatsink, or tower power supply case.
2. Remove all dirt and or dust with compressed air and small paint brush.
3. Pull the black patch off the fan to expose the bushing (power supply fans have a small metal cap or rubber plug that you remove to expose the bushing or bearing).
4. Spray a little WD40 into the bushing or bearing and apply power. Let the fan run for about 15 minutes.
5. Apply a couple of drops of machine oil to the bearings or bushing while it's running.
6. Reseal the bearing or bushing.

I use Petron Plus friction reducer. In my experience, it makes the fan bearings last a long time. I order it directly from Petron Plus Inc., at 937-254-9999, or fax them at 937-254-1118.

A special tip about a Hitachi HM4021D

Symptom: Yellowish raster with no retrace lines. No video.

Troubleshooting tip: When you are testing this monitor, you must connect a jumper wire from the ground on the video board and from the CRT shield. This a D.A.S. adjusted monitor and if you don't do this, you will corrupt the data in the EEPROM. Replace shorted Q500 and Q502, 2SA1207 transistors. These are located in the middle of the board. Replace C507 and C547, 1µF/160V capacitors. Use only 105 degree C caps. Check IC, VPS video output chip.

MCM Electronics®

Leading Supplier

To the Consumer Electronics Repair Industry

TENMA® 2MHz Digi-Scope™

The Digi-Scope™ combines a powerful 2MHz digital storage oscilloscope, true RMS autoranging DMM and 10MHz frequency counter. **Features:** •2.5" square backlit LCD display •200 x 200 resolution •RS-232 interface •Internal battery pack with charger •Includes holster and carry case

FREE Literature!

Hours: M-F 7 a.m. - 9 p.m.,
Sat. 9 a.m. - 6 p.m. EST.

When ordering please provide:
CODE: ES112

Prices effective October 1, through November 12, 1999

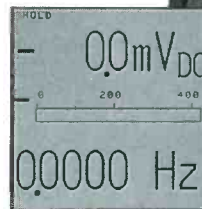

Order #72-6640

Only \$329

1-800-543-4330

fax 1-800-765-6960

Secured ordering at www.mcmelectronics.com



MCM ELECTRONICS®
850 CONGRESS PARK DR.
CENTERVILLE, OH 45459
A PREMIER FARNELL Company

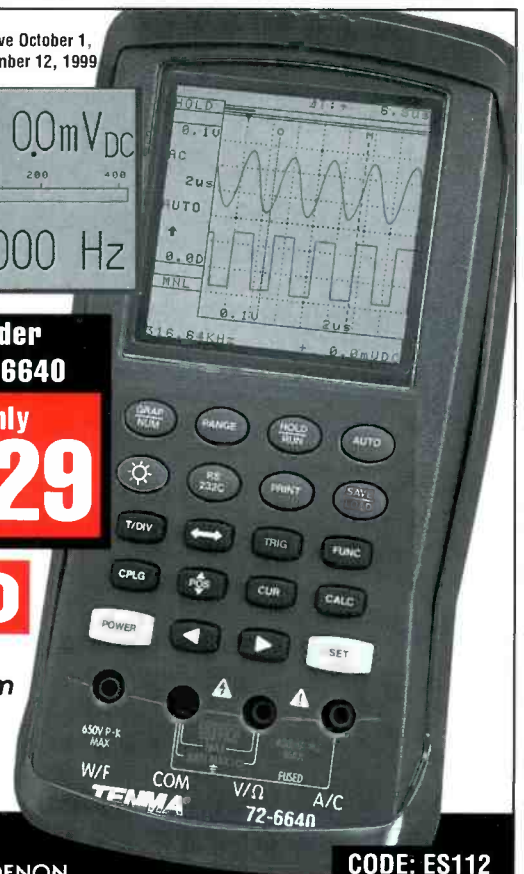

CODE: ES112

Premier Distributor
RCA **PROSCAN**

Your Authorized Replacement Parts Distributor for:
Panasonic PHILIPS Technics ECG Quasar DENON

How to set up the Proview 768M 17-inch monitor (FCC ID IJEPV-768)

Note: The tilt/rotate control is analog, and is located on the rear of the chassis and is also externally accessible.

Note: To move the on-screen display or the frequency OSD:

1. Momentarily press the front of bezel "User" (Mode) button.
2. You will then see a blue bar containing the current incoming video card input frequencies (horizontal and vertical) display (to change OSM or OSD position on the screen) A: Vert. position change only, use step 3 below. B: Horiz. position change only, use step 4 below.

3. Now momentarily press the (Adjust) *Up Arrow* button which will move the Position/Location (Vertical movement only) of the on-screen display (Frequency bar) and the On screen menu. (Menu bar) Both displays to the same screen area location. Note: the Menu display bar is on screen at this time, but is also moving concurrently with the same movement and position location of the frequency bar display. Only the OSD (Frequencies bar) is seen at this time, and not the OSM (On screen menu bar).

4. Now momentarily press the (Adjust) *Down Arrow* button, which will move the (Position/Location) (Horizontal movement only) of the on screen display, (Frequency bar), and the (On screen menu) (Menu bar) (Both displays) to the same on screen area location. Note: The (Menu display bar) is not seen at this time, but is also moving concurrently with the same movement and position location of the frequency bar display. Only the OSD (Frequencies bar) is seen at this time, and not the OSM (On screen menu bar).

5. Note: If the OSD or the OSM is positioned too close to the

bottom of the screen, you will see a slight line or vertical retrace line emanating from the right side of the OSM or OSD at the right side of the screen, close to the bottom right corner area.

Samsung CFG9637

Symptom: Not able to call up the on-screen display. This is a common problem.

Troubleshooting tip: Replace IC101, LM1205, and perform the following factory modification. Add a 7.5V, 1W zener diode between pin 13 of IC101 and ground. Replace jumper wire JP104 with a 100Ω 1/2W resistor. Replace the 300Vdc spark gaps on the red, green, and blue cathodes with 200Vdc replacements.

Sony CPD-17SF2

Being able to recognize what the status of the LEDs on this monitor during shut-down condition tell you about the condition can save you troubleshooting time. Following is a description of the LEDs for each condition.

1. Power-on green LED with power-saving mode yellow, color adjustment LED flashing. This is an indication of a software command shutdown.

2. Power-on green LED with power saving mode yellow LED, Geometry adjustment LED flashing. This an indication of a damaged high voltage circuit, or a damaged vertical circuit and its associated circuitry.

3. Power-on green LED with power-saving mode yellow-LED, Screen-size led flashing. This is an indication that the automatic brightness limiter (ABL) is having problems.

4. Horizontal deflection (scan failure) is not indicated by any combination of glowing or flashing LED displays. ■

ORGANIZE AND PROTECT YOUR COPIES OF

Electronic Servicing & Technology

Now there's an easy way to organize and keep copies of your favorite magazine readily available for future reference.

Designed exclusively for **ES&T** by Jesse Jones Industries, these custom-made titled cases and binders provide the luxury look that makes them attractive additions to your bookshelf, desk or any location in your home or office.

Whether you choose cases or binders, you'll have a storage system that's durable and well organized to help protect your valuable copies from damage.

Quantity	Cases	Binders
One	\$ 8.95	\$11.25
Three	\$24.95	\$31.85
Six	\$45.95	\$60.75

Add \$1.50 per case/binder for postage and handling. Outside USA \$3.50 per case/binder. (U.S. funds only)

- Cases and binders designed to hold a year's issues (may vary with issue sizes).
- Constructed of reinforced board, covered with durable red leather-like material.
- Cases V-notched for easy access.

- Free personalization foil for indexing year.
- Binders have special spring mechanism to hold individual rods which easily snap in. This allows magazines to be fully opened for easy readability.
- Title hot - stamped in gold.

Call TOLL FREE 7 days, 24 hours

1-800-825-6690

Electronic Servicing & Technology Jesse Jones Industries, Dept. 95 EST, 499 East Erie Avenue, Philadelphia, PA 19134

EXPAND YOUR KNOWLEDGE

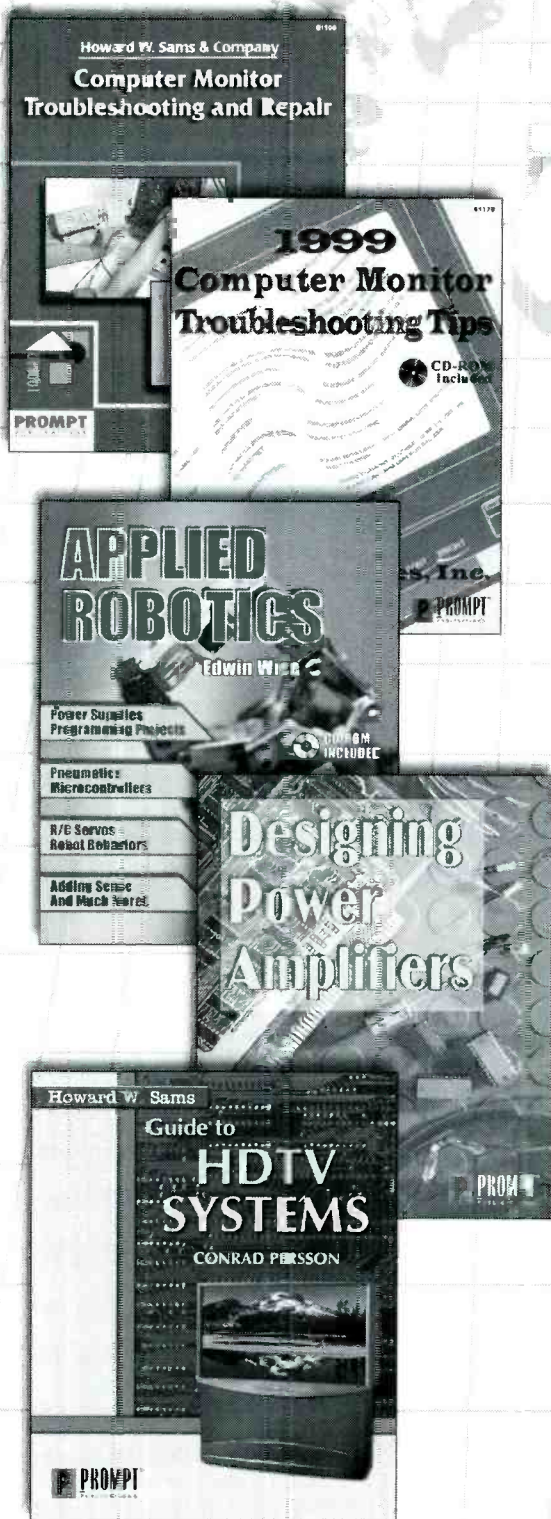

Computer Monitor Troubleshooting and Repair

by Joe Desposito & Kevin Garabedian

Technicians, hobbyists, and entrepreneurs will benefit from this book, which takes the reader through the basics and on to troubleshooting circuits including power supply, high voltage, and others.

Troubleshooting & Repair • 336 pages • paperback • 8-3/8" x 10-7/8"
ISBN 0-7906-1100-7 • Sams 61100 • \$34.95

1999 Computer Monitor Troubleshooting Tips

by M.I. Technologies

Contains over 3500 troubleshooting and repair tips listed by manufacturer name and model number from Apple, Acer, Compaq, CTX, Dell, Gateway, IBM, and more. CD-ROM is included.

Troubleshooting & Repair • 336 pages • paperback • 8-3/8" x 10-7/8"
ISBN 0-7906-1179-1 • Sams 61179 • \$49.95

Applied Robotics

by Edwin Wise

A hands-on introduction to the field of robotics, this book will guide the hobbyist through the issues and challenges of building a working robot. CD-ROM is included.

Electronics Technology • 328 pages • paperback • 7-3/8" x 9-1/4"
ISBN 0-7906-1184-8 • Sams 61184 • \$29.95

Designing Power Amplifiers

by Stephen Kamichik

This book is divided into two sections: Theory and Projects. The first section contains eleven chapters ranging from transformer-coupled amplifiers to push-pull amplifiers. The second section includes easy-to-construct projects on amplifiers, stereo headphone amplifier and the 100 Watt MOSFET audio power amplifier.

Electronics Technology • 256 pages • paperback • 7-3/8" x 9-1/4"
ISBN 0-7906-1170-8 • Sams 61170 • \$29.95

Guide to HDTV Systems

by Conrad Persson

This book provides a detailed background on what HDTV is, the technical standards involved, how HDTV signals are generated and transmitted, and a generalized description of the circuitry an HDTV set consists of.

Video Technology • 232 pages • paperback • 7-3/8" x 9-1/4"
ISBN 0-7906-1166-X • Sams 61166 • \$34.95

 **PROMPT**
PUBLICATIONS

Order at www.hwsams.com,
1.800.428.SAMS,
or visit your local electronics distributor.

A Bell Atlantic Company
Howard W. Sams

Circle (118) on Reply Card

Technology: Thermoelectric heating and cooling

by the ES&T Staff

Most people are familiar with the magic of air conditioning and refrigeration. Noisy machinery moves, and somehow the air in an enclosed space is cooled. There is another method of cooling that most people are not familiar with, but the technology is fascinating, and the process is silent. This method is called thermoelectric cooling. Because it's electronic in nature, and because this method of cooling may be used to cool electronic circuits, we thought that readers might be interested to know a little bit about what it is, and how it works.

Thermoelectric modules

A thermoelectric module is a small solid state device (Figure 1) that can operate as a heat pump or as an electrical power generator. When used to generate electricity, the module is called a thermoelectric generator (TEG). When used as a heat pump, the module utilizes a phenomenon known as the *Peltier effect* to move heat and is called a thermoelectric cooler (TEC).

The Peltier effect

The Peltier effect was discovered in 1834. When current passes through the junction of two different types of conductors, it results in a temperature change. The practical application of this concept, however, required a long wait, until the development of semiconductors that are good conductors of electricity, but poor conductors of heat: the perfect balance for TEC performance. Today, bismuth telluride is primarily used as the semiconductor material, heavily doped to create either an excess (n-type) or a deficiency (p-type) of electrons.

Operation of a TEC

Very simply, a TEC consists of a number of p-type and n-type pairs (couples) connected electrically in series and sandwiched between two ceramic plates (Figure 2). When connected to a dc power

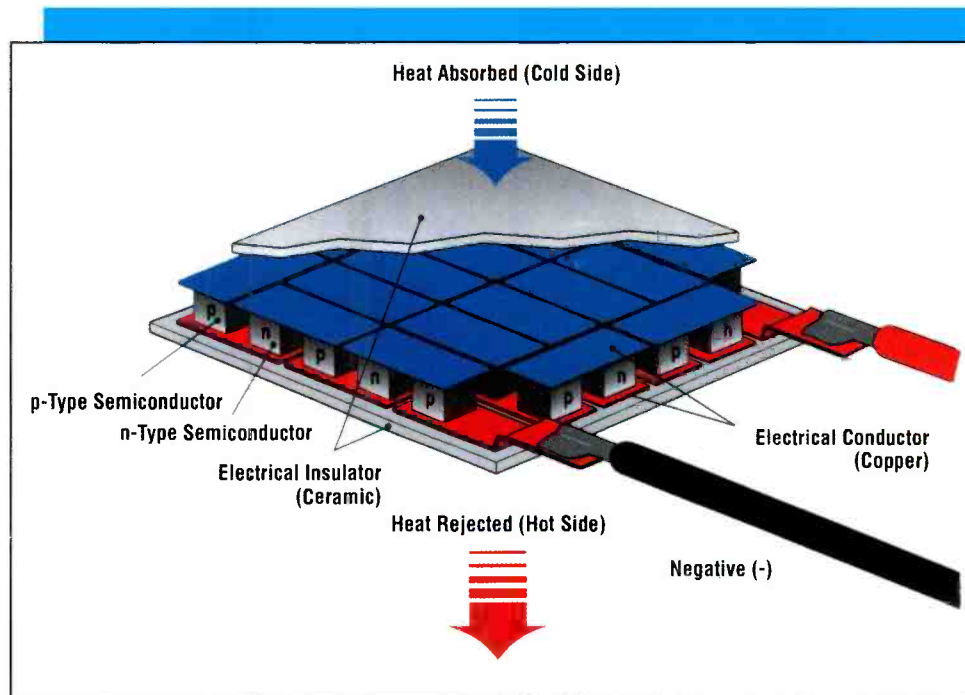

Figure 1. A cutaway drawing of a thermoelectric (TE) module.

source, current causes heat to move from one side of the TEC to the other. Naturally, this creates a hot side and a cold side on the TEC. A typical application exposes the cold side of the TEC to the object or substance to be cooled and the hot side to a heatsink, which dissipates the heat to the environment. A heat exchanger with forced air or liquid may be required. (As clever as TECs are, they can't eat heat — only move it).

Reversing the direction

If the current is reversed, the heat is moved in the opposite direction. In other words, what was the hot face will become the cold face and vice-versa.

Could it cool my house?

The maximum amount of heat the largest single TEC can pump is about 125W. So, you wouldn't cool your house with it. The modular design enables the

user to use several TECs per application, allowing them to move more heat.

Using multiple TECs

TECs can be used side-by-side to increase the amount of heat pumped, or they can be stacked on top of one another to increase the temperature difference across the TEC. When stacked, they are called "cascades," or multistage TECs. When the temperature difference between the hot and cold faces doesn't need to be more than about 60 degrees, single-stage TECs can normally do the job. If the temperature difference needs to be greater than 60 degrees, cascades should be considered.

A TEC vs. a compressor

TECs are absolutely perfect for some applications and completely unsuitable for others. Depending on the application, a TEC can be much, much better than a com-

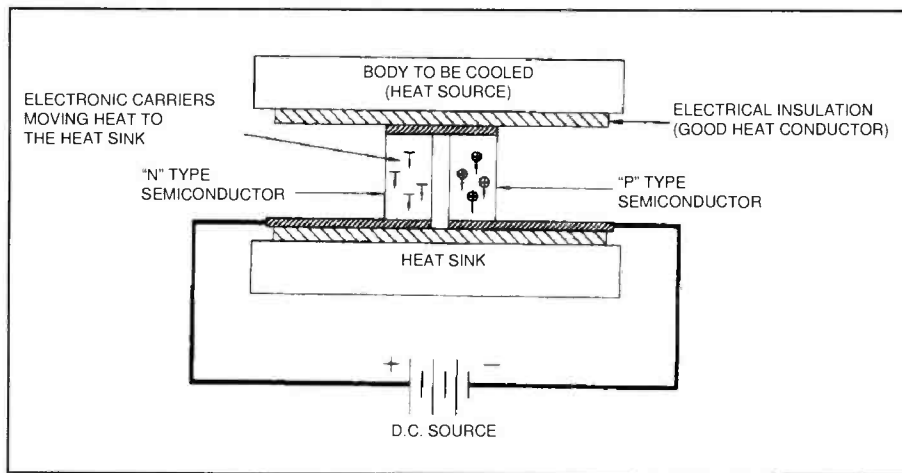

Figure 2. Cross section of a typical TE couple (TEC).

pressor or no match at all. TECs are very small, very light, and completely silent. With no moving parts, they are extraordinarily reliable. TECs generate little, if any, electrical noise and can provide precision temperature control when used with an appropriate controller. They can be operated in a vacuum or weightless environment, and in any physical orientation.

On the other hand, TECs tend to lose their competitive advantage when cooling loads exceed 200W. Under some special circumstances, however, TECs are used to pump loads of tens of kilowatts.

Designing a TEC

Designing a TEC is not really difficult. It does require some understanding of heat transfer and a good grasp of your application. Melcor has developed a thermoelectric selection/design software program AZTEC(A to Z Thermoelectric Cooling) that is a free download from its website at www.melcor.com, and the company's experienced engineers are available to help.

What special equipment or framing is required to install a TEC?

Proper installation is extremely important but not very difficult. The manufacturer provides detailed, illustrated assembly instructions. And, they can build custom subassemblies for companies that have specific applications.

Temperature control and power supplies

TECs are DC devices. The amount of the heat through the TEC is directly proportional to the power supplied. Temp-

erature is controlled through manual or automatic means. The automatic controller can range from a simple on-off thermostat to a complex computer controlled feedback circuit. Such control systems are available from a variety of qualified manufacturers.

A comparison of thermoelectric cooling with vapor compression systems

Since thermoelectric cooling systems are most often compared to conventional vapor-compression systems, perhaps the best way to show the similarities in the two refrigeration methods is to describe and compare them.

A conventional cooling system contains four fundamental parts :

- the evaporator,
- compressor,
- condenser,

- and a metering control device (expansion valve).

The evaporator, or cold section, is the part where the liquid portion of the two-phase refrigerant is allowed to boil and evaporate. During this change of state from liquid to gas, energy (heat) is absorbed. The compressor acts as the refrigerant pump and compresses the gas. The condenser expels the heat absorbed at the evaporator, along with the heat produced during compression, into the environment or ambient. Then the control valve changes the pressure of the refrigerant gas, allowing it to absorb heat when it enters the evaporator.

A thermoelectric system

A thermoelectric system has analogous parts. At the cold junction, energy (heat) is absorbed by electrons as they pass from a low energy level in the p-type semiconductor element, to a higher energy level in the n-type semiconductor element. The power supply provides the energy to move the electrons through the system. At the hot junction, energy is expelled to a heat sink as electrons move from a high energy level element (n-type) to a lower energy level element (p-type). The use of elements of different materials (p and n) creates the energy change responsible for the heat transfer, similar to the expansion valve's role in a conventional refrigeration system.

Another analogy often used to help comprehend a TE cooling system is that of a standard thermocouple used to measure temperature. Thermocouples of this

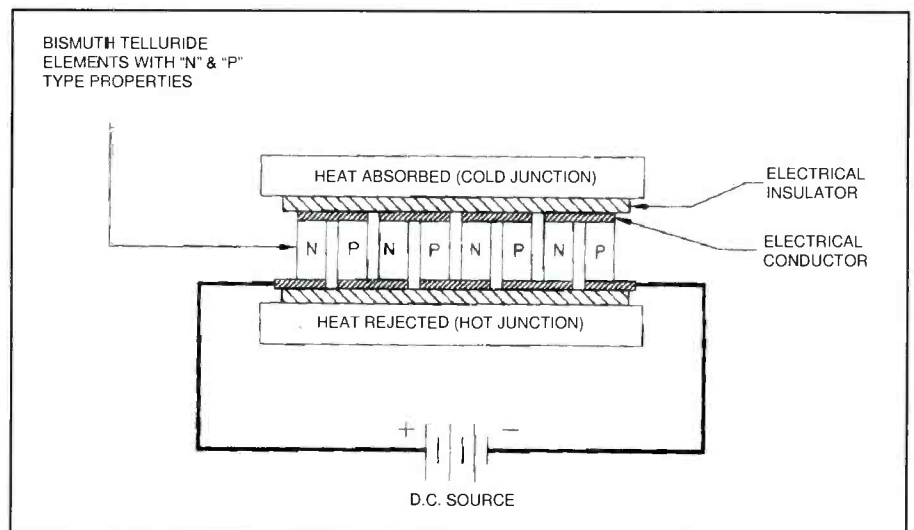

Figure 3. Typical TE module.

What's Your Best Servicing Value?
The magazine that makes money for you!

THE PROFESSIONAL MAGAZINE FOR ELECTRONICS AND COMPUTER SERVICING
ELECTRONIC
Servicing & Technology



As an electronic servicing professional, it's crucial for you to keep current in an industry that's always growing and changing.

Each month, **ES&T** brings you how-to service articles on TVs...VCRs... Computers... CD players...Microwave ovens...Audio products and more. It's the information you need to do your job every day.

Regular columns and special features from experts will make you more efficient – and more profitable – in no time. Plus, our monthly PROFAX, a FREE 8-page pull-out of popular TV, VCR and computer schematics, makes **ES&T** an even greater value.

Subscribe today to the only magazine devoted to you!

SUBSCRIBE TODAY!!

United States	
1-yr (12 issues)	\$26.95
2-years (24 issues)	\$49.95
Canada/Mexico	
1-yr (12 issues)	\$36.95
2-years (24 issues)	\$69.95
Foreign Air Post	
1-yr (12 issues)	\$44.95
2-years (24 issues)	\$85.95

When ordering include: Name, address, city, state, zip. Check, money order, MasterCard, VISA, Discover, and American Express accepted. Send credit card number along with expiration date. If renewing, send a label along with your request.

Send all Subscription requests to:
Electronic Servicing & Technology
25 Newbridge Road, Hicksville,
NY 11801 Ph: 516-681-2922
FAX: 516-681-2926

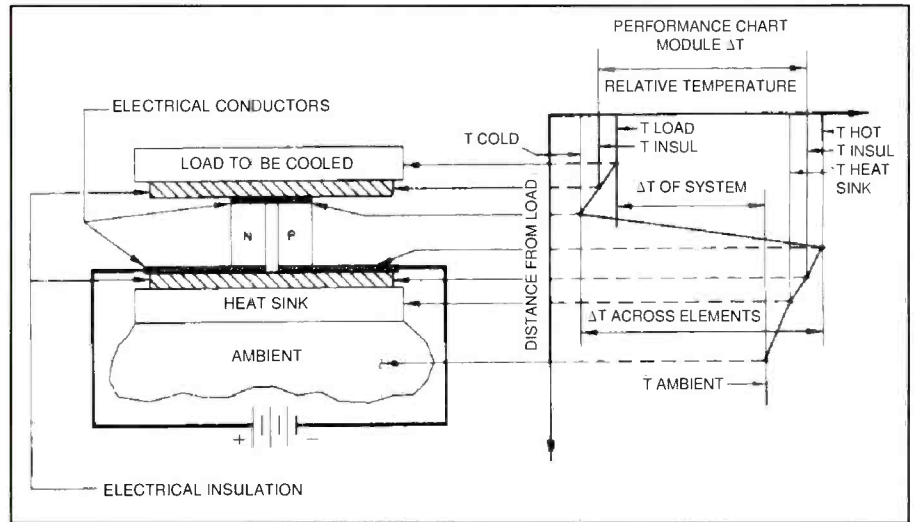

Figure 4. Typical temperature relationship in a TEC.

type are made by connecting two wires of dissimilar metal (typically copper/constantan), in such a manner so that two junctions are formed. One junction is kept at a reference temperature, while the other junction is attached to the object being measured. The generated voltage is measured by a sensing device, which converts the magnitude of the generated voltage to a reading. Reversing this train of thought, imagine a pair of fixed junctions into which electrical energy is applied, causing one junction to become cold while the other becomes hot.

Thermoelectric couples (Figure 2) are made from two elements of semiconductor, primarily bismuth-telluride, heavily doped to create either an excess (n-type) or deficiency (p-type) of electrons. Heat absorbed at the cold junction is pumped to the hot junction at a rate proportional to current passing through the circuit and the number of couples.

Building a module

In practical use, couples are combined in a module (Figure 3) where they are connected electrically in series, and thermally in parallel. Normally, a module is the smallest component commercially available. Modules are available in a great variety of sizes, shapes, operating currents, operating voltages, and ranges of heat pumping capacity. The user can select the quantity, size, or capacity of the module to fit the exact requirement without paying for excess power.

There is usually a compelling reason to use thermoelectrics instead of other forms

of cooling. The reason may be a special consideration of size, space, weight, reliability, or environmental conditions, such as operating in a vacuum. If none of these are a requirement, then other forms of cooling should be considered and, in fact, are probably preferable.

Selecting the thermoelectrics

Once thermoelectrics have been decided upon, the next step is to select the thermoelectric(s) that will satisfy the specific set of requirements. Three specific system parameters must be determined before device selection can begin. These are:

- T_C (Cold Surface Temperature)
- T_h (Hot Surface Temperature)
- Q_C (The amount of heat to be absorbed at the Cold Surface of the T.E.)

Cooling to the desired temperature

In most cases, the cold surface temperature is usually given as part of the problem; that is to say that an object(s) is to be cooled to some specified temperature. Generally, if the object to be cooled is in direct intimate contact with the cold surface of the thermoelectric, the desired temperature of the object can be considered the temperature of the cold surface of the T.E. (T_C). There are situations where the object to be cooled is not in intimate contact with the cold surface of the T.E., such as volume cooling, where a heat exchanger is required on the cold surface of the T.E. When this type of system is employed, the cold surface of the T.E.

(T_C) may need to be several degrees colder than the desired volume temperature.

Hot surface temperature

The Hot Surface Temperature is defined by two major parameters:

1) The temperature of the ambient environment to which the heat is being rejected.

2) The efficiency of the heat exchanger that is between the hot surface of the T.E. and the ambient. These two temperatures (T_C and T_h) and the difference between them (ΔT) are very important parameters and must be accurately determined if the design is to operate as desired. Figure 4 represents a typical temperature profile across a thermoelectric system.

Quantifying the amount of heat to be removed or absorbed

The third, and often most difficult parameter to accurately quantify, is the amount of heat to be removed or absorbed by the cold surface of the T.E. All thermal loads to the T.E. must be considered. These thermal loads include, but are not limited to, the active or I^2R heat load from electronic devices and conduction through any object in contact with both the cold surface and any warmer temperature (i.e. electrical leads, insulation, air or gas surrounding objects, mechanical fasteners, etc.). In some cases, radiant heat effects must also be considered.

Single stage thermoelectric devices are capable of producing a "no load" temperature differential of approximately 67C. Temperature differentials greater than this can be achieved by stacking one thermoelectric on top of another. This practice is often referred to as cascading. The design of a cascaded device is much more complex than that of a single stage device, and is beyond the scope of this article. Should a cascaded device be required, design assistance can be provided.

Selecting a module

Once the three basic parameters have been quantified, the selection process for a particular module or group of modules may begin. Some common heat transfer equations are included in this catalog for help in quantifying Q_C and T_h .

There are many different modules or sets of modules that could be used for any specific application. One additional criterion that is often used to pick the "best" module(s) is Coefficient of Performance (COP). COP is defined as the heat absorbed at the cold junction, divided by the input power (Q_C/Q_{in}). These advantages come at a cost, which in this case is the additional or larger T.E. device required to operate at COP maximum. It naturally follows that an advantage of the minimum COP case is often a lower initial cost.

Power supply and temperature control are additional items that must be considered for a successful T.E. system. A thermoelectric device is a DC device. Any AC component on the DC is detrimental. Degradation due to ripple can be approximated by:

$$\Delta T/\Delta T_{max} = 1/(1+N^2), \text{ where } N \text{ is } \% \text{ current ripple.}$$

Example

The effect on T_{max} for a power supply with 20% ripple.
 $\Delta T_{max} = 67C$

$$\Delta T / T_{max} = 1/(1+N^2) = 1/(1+0.2^2) = 0.96$$
$$\Delta T = T_{max} \times 0.96 = 64C$$

Ten percent ripple, or less, is recommended.

Temperature control

Temperature control with thermoelectrics can be generally considered as one of two groups: "open loop" and "closed loop," or manual and automatic. Regardless of method, the easiest device parameter to detect and measure is temperature. Therefore, the cold junction (or hot junction in heating mode) is used as a basis of control. The controlled temperature is compared to some reference temperature, usually the ambient or opposite face of the T.E.

In the Open Loop method, an operator adjusts the power supply to reduce the error to zero. A closed loop accomplishes this task electronically. The various control circuits are too numerous and complex to try to discuss in this text. Suffice it to say that the degree of control, and consequent cost, varies considerably with the application.

This article was based, with permission, on information previously published in the Melcor 40th Anniversary Catalog. For further information on the subject of thermoelectric cooling, visit the company's website at www.melcor.com, or send them an E-mail at tecooler@melcor.com, or call them at 609-393-4178. ■

Electronic Technicians Association - ETA

and

Satellite Dealers Association - SDA

present

The Ultimate Customer Service Specialist Study Guide

CSS-2

The second edition of this popular CSS Study Guide
is now in print.



Twice the number of pages



Twice the chapters



Dozens of new practice quiz questions

Sales-marketing-service relationships; Technoliteracy; Safety; Company standards; Dependability; Teamwork; Work ethics; Problem solving; Company loyalty; Telephone techniques; Controlling your emotions; Communications; Record keeping; Safety; Decision making; Customer service techniques; Hygiene, and more

No Service Business Should be Without One of These
Unique Guides to World Class Service!

to order

Call 800 288 3824

eta@indy.tdsnet

ETA-I

602 N Jackson, Greencastle, IN 46135

CIRCLE 72 ON READER SERVICE CARD

Products

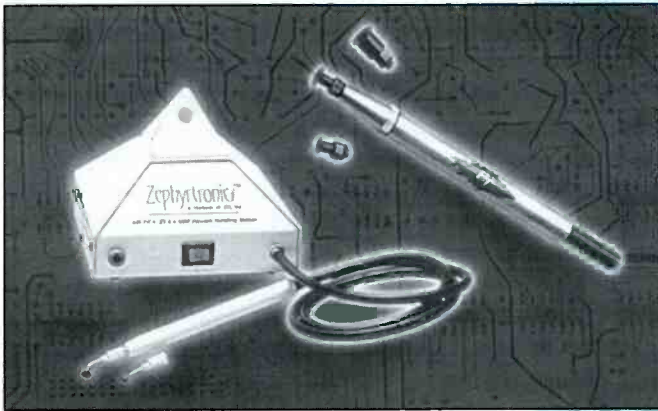

Vacuum pens

Emulation Technology announces two new vacuum pens — one operated manually, the other electrically powered.

The AirPick is an electrically powered handling system used to lift and move miniature surface mount devices and small components. It has a self-contained vacuum pump and no hoses or air hookups. Without bulbs to squeeze, buttons to push, or handles to depress, it's easy to use.

A manually operated handling tool, the hand-held Vacuum Pen, has a suction handle allowing users to easily pick up ICs without damaging them. It eliminates the need to touch fragile QFP and SOIC packages. To operate this handheld vacuum pen, you simply screw on the size cup you need, depress the plunger on the top of the pen, place the pen on the device, and then release the plunger to create a vacuum.

Emulation Technology, 2344 Walsh Avenue, Building F, Santa Clara, CA 95051-1301, Phone: 1-800-ADAPTER, Fax: 408-982-0664

Circle (80) on Reply Card

Mini multiscop

Extech's new handheld oscilloscope/multimeter combinations, the mini multiscop, features a dc to 100kHz oscilloscope



with a sample rate of 1 million samples/second. The single channel oscilloscope range is 150mV to 800V/division and 10μseconds/div to 1second/div, 500 ns glitch capture, and pre/post (-4 div./+10 div.). The oscilloscope display is a 128 x 64 pixel graphic LCD with a view area of 2.8 x 1.5". Multimeter functions include true RMS ac voltage and current, dc voltage and current, resistance, capacitance, frequency, dB, temperature (using optional adaptor), duty cycle, pulse

width, period, TTL signal generator, diode and continuity tests. The multimeter display incorporates data hold on a 400 count LCD with bargraph. Standard features offered by this test instrument include record/recall of min/max/average with time stamping, store and recall 15 waveforms plus setup, over-range indication, and auto power off. Complete with rubber holster, built-in stand, batteries, fuses, test leads, and alligator clips.

Extech Instruments, 335 Bear Hill Road, Waltham, MA 02451, Phone: 781-890-7440, Fax: 781-890-7864, E-mail: extech@extech.com, Website: www.extech.com

Circle (81) on Reply Card

PC card DMM product

AeroAstro has completed development of the "DMM Card." This PC Card operates as a digital multimeter with high voltage capability (350 Vrms) and datalogging in a single package. These Type II PC Cards measure voltage, resistance, and current (with an external shunt) and include all overvoltage protection in all operational modes on the card itself. Windows 3.x compatible software to run these cards is included with this product. Windows 95 compatible software is expected to be released later this year. Windows 3.x units are available now.

Mobile computing has become one of the fastest growing areas in the computer industry. Today, a large number of computer users on the run are equipment service technicians who use their computers to log their account visits and communicate to the factory. The DMM Card is based on the basic idea that field technicians should be able to use their computers to make relevant measurements on the equipment being serviced. Furthermore, using the computer and having seamless measurement equipment embedded in the computer in the form of a PCMCIA card provides automated testing on the road.

AeroAstro, 550 E. Rogers Rd., Longmont, CO 80501, Phone: 303-651-7552, E-mail: dmm@aeroastro.com, Web: <http://www.aeroastro.com/dmm>

Circle (82) on Reply Card

Dataline isolator

The new Model 232SPH14 optical isolator from B&B Electronics protects PCs and associated equipment from lightning surges, high voltage shortages and ground loops on datalines. The unit supports RTS and CTS handshake lines and TD and RD communications lines. It will handle RS-232 communications up to 115.2K bps.



Optical isolators work by putting an optical link in the dataline. The data signal is converted to light which can cross it, but electrical current cannot. In addition to 4KV of isolation, the product meets creepage and air clearance requirements for double or rein-

forced insulation of IEC 601-1.

The product has a DB25 female plug to fit into a PV or its connecting cable. A DB25 male connector plugs into the DCE device.

B&B Electronics, 707 Dayton Road, Ottawa, IL 61350, Phone: 815-433-5100,
Fax: 815-433-5105, Website: www.bb-elc.com

Circle (83) on Reply Card

Digital phosphor oscilloscope

Tektronix introduced its second family of digital phosphor oscilloscopes (DPO), the TDS3000.

DPOs display, store, and analyze in real-time, using three dimensions of signal information: amplitude, time, and the distribution of amplitude over time. This provides the intensity-graded display and responsiveness of an analog oscilloscope, combined with the storage and measurement capabilities of a digital storage oscilloscope (DSO).

Six models of the TDS3000 are available. The series' color display helps hardware engineers and technicians designing integrated systems delineate between multiple channels. The advanced logic and pulse triggering, as well as the Fast Fourier Transform (FFT) analysis capabilities of the product, simplify the verification phase of design. Furthermore, during the debug process, the DPO's intensity-graded display indicates the relative frequency of signal anomalies.

For use in servicing video systems, the unit displays all the video content of the signal being observed as on an analog oscilloscope, plus a video module provides line count triggers to help the technician capture the video signal of interest.

Tektronix, P.O. Box 3960, Portland, OR 97208-3960, Phone: 800-426-2200,
Fax: 503-222-1542

Circle (84) on Reply Card

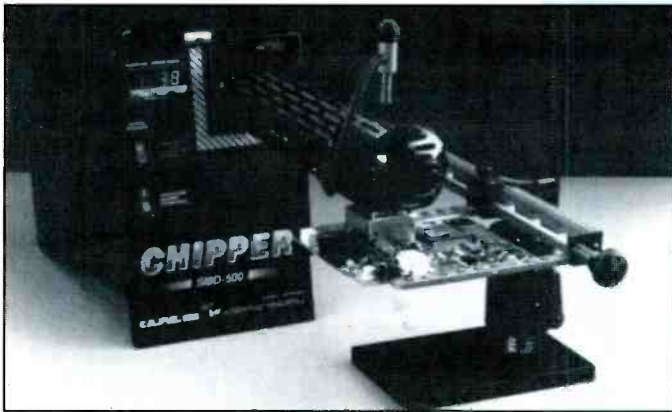

Rework system

The A.P.E. Chipper SMD-500 is a compact, benchtop hot air based rework system designed for the removal and replacement of most surface mount (SMT) electronic components. The unit combines low temperature, low velocity high power heating to allow rework at low temperatures. The system used the same heater and blower assembly as the company's more advanced rework system, only with a simple heating control system and fewer "bells and whistles."

Features include low temperature operation with accurate closed-loop temperature monitoring of a patented high-power heater. This reduces rework temperatures below 232 degrees Celsius and an automatic vacuum pick-up assembly lifts the part

from the board once eutectic temperature has been reached and continues to hold the part during the cooling cycle.

Automated Product Equipment Corp., 48 Coral Way, MM 105.2, Key Largo, FL 33037, Phone: 305-451-4722, Fax: 305-451-3374, Website: www.apecorp.com

Circle (85) on Reply Card

Toolbox for Cat 5 and coax installation

Cable University has introduced a new toolbox for installers of communications cabling. The "Wire U Toolbox" contains the tools needed for installation of Category 3 and 5 unshielded twisted pair cabling used in data-voice cabling installations and coax cable for CATV and CCTV.

The Wire U Toolbox was developed for teaching hands-on data, voice, and video cabling installation in the Wire U training programs. It includes a full set of tools for installing, terminating, and testing coaxial cables for video (CATV or CCTV) and Category 3 and 5 UTP (unshielded twisted pair) cables for data-voice structured cabling systems.

Tools included allow terminations of coax cable with "F" and "BNC" connectors and UTP cables with RJ-45 connectors and "110" or "66" punchdown blocks. Cable cutters, jacket strippers and crimpers are included for all types of cable and terminations. Test equipment includes a toner for tracing cables and a wiremapper for testing UTP cable for proper wiring termination. Only a "Cat 5" tester needs to be added to provide dynamic testing of installed cables.

Cable University, 151 Mystic Avenue, Medford, MA 02155-4615, Phone: 781-396-6155, Fax: 781-396-6395, E-mail: info@fotec.com, Website: www.fotec.com

Circle (86) on Reply Card

RS-232 to RS-422/485 converter

Optical isolation and traffic indicating LEDs are two of the features that define the Model 485OTLED RS-232 to RS-422/485 data interface converter from B&B Electronics. Converting the RS-232 TC output format to the RS-422 format allows data communication up to 4,000 feet, compared to the 50 feet normally reached. Using the RS-485 signal allows up to 32 drops on a two-wire system and use of the Automatic Send Data Control which lets the hardware control the drivers, eliminating software overhead.

The unit is housed in a streamlined case which encloses and protects the terminal block connections on the RS-422/485 side. The RS-232 side has a DB25 Female plug. It supports full or half-duplex signal at baud rates up to 115.2 kbps.

B&B Electronics, 707 Dayton Road, Ottawa, IL 61350, Phone: 815-433-5100,
Fax: 815-433-5105, Website: www.bb-elc.com

Circle (87) on Reply Card



Photofacts

DAEWOO	CT-27G14UA4199	VWM-648.....VCR-314
CN-001A4205	DP330.....4199	VWM-662.....VCR-314
DTQ-13P2FC4205	JP330.....4199	
DTQ-13P3FC4205		
	PHILIPS MAGNAVOX	
EMERSON	MX3691B101.....4197	
ET-13P2.....4206	13PR18C1214202	
	QUASAR	
FISHER	BC3274201	
FVH-T617.....(sim to) VCR-314	SP2022DA4201	
FVH-T667S.....(sim to) VCR-314		
	RCA	
FUNAI	CTC197AH24196	
F4819U.....4203	F27681GYFE14196	
	SANYO	
PANASONIC	VHR-H647.....VCR-314	
AP330.....4199	VHR-H697.....VCR-314	
CT-27G14A4199		
CT-27G14DA4199		
		SONY
		KV-27V454200
		KV-27V654200
		SCC-S01M-A4200
		SCC-S01N-A.....4200
		SCC-S03J-A4200
		SCC-S03K-A4200
		SYMPHONIC
		ST49134204
		TOSHIBA
		CF19H254198
		CZ13M214207
		ZENITH
		A32B43W4195

News (from page 3)

"CEMA does not object in principal to the creation of a low power FM radio service, but we believe lifting the interference restriction to do so would adversely effect consumers' investment in the 710 million FM receivers currently in use in the United States," explained Gary Shapiro, CEMA president. "We have found that current home, portable, and mobile FM receivers would not be able to distinguish LPFM signals from the signals of established commercial radio stations, thus limiting consumers' ability to listen to either source."

At issue are the second adjacent, third adjacent, and intermediate frequency channel protections currently mandated by the FCC. These rules specify the acceptable relative signal strength levels of stations broadcasting on neighboring radio frequencies. The rules are designed to provide enough geographic distance and/or radio frequency separation for FM receivers to reject unwanted signals in favor of the selected programming.

"The current restrictions are the minimum required to prevent stations from interfering with each other," noted Ralph Justus, CEMA director of Technology and Standards. "Our tests found that even modern FM radios will experience extensive objectionable interference if the LPFM service is deployed as proposed. Further, the LPFM service would threaten some emerging digital broadcast formats that could bring consumers more services and higher quality than is currently possible."

BACK ISSUES

Complete your collection today.



ELECTRONIC
Servicing & Technology
How antennas work
Understanding SCS
Managing a service center



ELECTRONIC
Servicing & Technology
Service aids
Replacement parts showcase

Only
\$4.00
Per Issue

Check, Money Order,
Mastercard, VISA,
Discover and AMEX
accepted

25 Newbridge Road,
Hicksville, NY 11801
Phone 516-681-2922
FAX 516-681-2926



ES&T Presents Computer Troubleshooting & Repair
Features information on repairing Macintosh computers, a CD-ROM primer, and a color monitor. Also included are hard drive repair tips and computer diagnostic software.
61087 • \$24.95

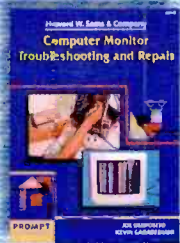

Computer Monitor Troubleshooting & Repair
Learn the basics of computer monitors with chapters on tools and test equipment, monitor types, special procedures, how to find a problem, and how to repair faults in the CRT.
61100 • \$34.95



1999 Computer Monitor Troubleshooting Tips
Includes over 2,000 troubleshooting and repair tips listed by manufacturers name and model number featuring such major names as Apple, Gateway, Compaq, IBM, and Dell.
CD-ROM Included™
61179 • \$49.95



ES&T Presents the Test Equipment Guide
Includes the latest information on how to choose the best equipment, how to build test equipment and accessories, how to set up the ideal service bench, and how to put together a practical tool kit.
61089 • \$24.95



Complete VCR Troubleshooting & Repair
In addition to troubleshooting procedures, this book contains nine detailed VCR case studies, each focusing on a particular model of VCR with a very specific and common problem.
61102 • \$34.95



Semiconductor Cross Reference, 4th Edition
With more than 490,000 part numbers, type numbers, and other identifying numbers listed, technicians will have no problem locating the replacement or substitution information needed.
61080 • \$29.95
Also available on CD-ROM.
61140 • \$29.95



ES&T Presents TV Troubleshooting & Repair
Presents important and new information that will make it possible for technicians, students, and electronics hobbyists to service TVs faster, more efficiently, and more economically.
61086 • \$24.95



Complete Projection TV Troubleshooting & Repair
Covers everything from the basics of projection circuits, tools and test equipment, TV types, safety procedures and measurements, to the finely detailed repair techniques.
61134 • \$34.95

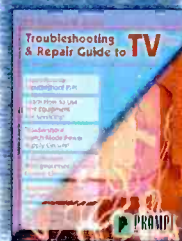

Troubleshooting & Repair Guide to TV, Second Edition
The most comprehensive, complete, and up-to-date television repair book available, with tips on how to troubleshoot the newest circuits in today's TVs.
61146 • \$34.95



ES&T Presents VCR Troubleshooting & Repair
This book provides in-depth and thorough information on a variety of VCR troubleshooting and repair areas.
61158 • \$24.95



Howard W. Sams Servicing Series RCA/GE Televisions
From RCA component numbering systems to the infamous "tuner wrap" problem, this book gives you all you need to make more efficient repairs.
61171 • \$34.95

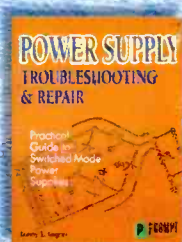

Power Supply Troubleshooting & Repair
Designed to provide technicians with a better understanding of how switched-mode power supplies operate. It also provides practical, useful procedures to follow when troubleshooting power supplies.
61138 • \$24.95

YES! I want to learn from the experts. Rush me my book(s) right away!

Please add \$4 shipping & handling. **FREE** shipping & handling for orders \$50 and over.

Please make your check or money order payable to: Electronic Servicing & Technology U.S. and possessions - add \$4 shipping/handling. **FREE** S/H on orders \$50 and over. Foreign - shipping/handling charges are calculated by order weight & destination. A \$4 credit will be applied for Foreign orders over \$50.

To Order Call
800-853-9797

Qty	Order#	Description	Price	Total Price
Shipping/Handling				
New York Residents add applicable sales tax				
Total				

Name _____

Address _____

City _____ State _____ Zip _____

MC/VISA/AMEX/Discover # _____ Expires _____

Form of payment: MC VISA AMEX Discover Check Money Order

Please mail your orders to: Electronic Servicing & Technology, 25 Newbridge Rd., Hicksville, NY 11801-9962 FAX: 516-681-2926

Classified

Classified advertising is available by the word or per column inch.

By-the word. \$1.65 per word, per insertion, pre-paid Minimum charge is \$35 per insertion. Initials and abbreviations count as full words. Indicate free category heading (For Sale, Business Opportunities, Miscellaneous, Wanted). Blind ads (replies sent to ES&T for forwarding) are \$40 additional. No agency discounts are allowed for classified advertising by the word. Contact Alycia Nichol森 at 516-681-2922 to place your classified ad (by-the-word). Mastercard, VISA, American Express and Discover are accepted for FAX or mail orders.

Per column Inch (classified Display): \$235 per column inch, per insertion, with frequency discounts available, 1" minimum, billed at 1/4" increments after that 10" maximum per ad. Blind ads are \$40 addition. Reader Service Number \$25 additional to cover processing and handling costs. (Free to 4-inch or larger ads.) For more information regarding classified display advertising please call 516-681-2922. Optional color (determined by magazine) \$150 additional per insertion.

**Electronic Servicing & Technology, 25 Newbridge Rd, Hicksville, NY 11801 Attn: Classified Department
Ph: 516-681-2922 FAX: 516-681-2926**

FOR SALE

SERVICE TIPS for FREE!!! ***** That's right it's **FREE!!!**
PROFESSIONAL BOARD LEVEL & COMPONENT LEVEL REPAIRS for TV's, VCR's, Projection TV's, CAMCORDER's, CD Players, Audio and other repairs on computer disk. **ADD** your own repair tips. **PRINT** out repair tips. **BACKUP** & save Your repairs. Want to share your own repair tips? If you do, we will send you **FREE** Updates!!! Ask about our **TIP EXCHANGE** policy. For IBM compatible computers with a hard drive and some Apple Macs. **Get your FREE Stage 1 SERVICE TIPS PROGRAM Now!!!** ***** **FREE CALL — CALL NOW!!! CALL 1-800-215-5081. *******

WinSTIPS! — over 120,000 Current tips from repair shops! All brands. Monitor and Consumer Electronics. Search any phrase. Vcrcross, Sams, Philips Ecg. One-button update Tips. Windows 95/98 **\$149.95** (CD or Web download). <http://www.kdtviwe.com>. KD TV 514 3rd St., Aurora, IN 47001. **1-888-KD-STIPS**. All c/cards. Ken Hull C.E.T. **WinSERV** Service software \$299.95. **ServiceTalk** professional email group. Full registerable downloads, runs **FREE** for 30 days.

IN-CIRCUIT ESR TESTER - Find bad caps **FAST** and **RELIABLY** with the new Capacitor Wizard in-circuit ESR Tester! Great for monitors switching power supplies, TVs, etc. Only \$179.95. MC/VISA. **Independence Electronics, Inc., 800-833-1094, www.awiz.com**

PRICE REDUCTION. Diehl Mark III \$39, Diehl Mark V Horizontal circuit tester \$159. Conductive coating for remote control keypads \$9.99 ppd. **WEEC, 2411 Nob Hill Road, Madison, WI 53713. 608-238-4629. Website: http://sites.netscape.net/duaneconger**

SENCORE, TEKTRONIX, HEWLETT PACKARD (all models). We **BUY, SELL, & TRADE**. Please call "**CHOICE ELECTRONICS**" for all of your test equipment needs. Complete financing options available. Call 1-800-609-0677, 605-361-6386 ask for Lance Tople.

TV CASE HISTORIES: Volume 7 with 3,045+ histories. Satisfaction assured. Only \$59 (plus \$3.25 shipping). Over 9,450 books and supplements sold with only 1 returned for a refund! **Mike's Repair Service, P.O. Box 217, Aberdeen Proving Ground, MD 21005.** Same mailing address 35+ years. Send SASE for samples. 410-272-4984, 1-800-2-FIX-TV5 11a.m.-9 p.m. (<http://mikesrs.webjump.com>)

WILL SELL Sencore VC-93 VCR Analyzer, with manuals, guarantee stickers. In excellent condition. \$2000.00 or best offer. Please contact **Jim at (972) 423-8828** or via e-mail jim.pratt@aethos.com

FOR SALE

TEST EQUIPMENT BOUGHT & SOLD: OSCILLOSCOPES, ETC. 925-706-0177. FAX: 925-706-0156. www.oscilloscopesetc.com

****NAP Tuner 340309**** RCA Tuner TCHRIA or TCCRIA and more. Snowy picture? Will rebuild for \$25.00, Free Shipping!!! Tip Top TV & VCR, 18441 Sherman Way, Reseda, CA 91335, 818-345-1974.

TEST EQUIPMENT FOR SALE: REASONABLE PRICES SENCORE, TEKTRONIX, HP and MUCH MORE. View complete list at: <http://www.astglobal.com> or contact: **AST GLOBAL ELECTRONICS.** Voice: 888-216-7159; Fax 814-398-1176; e-mail: sales@astglobal.com

RCA/Panasonic/Samsung "drop in" Power supplies, WE REBUILD \$39 flat p&L, FREE SHIPPING Tel-Rad Service, 686 Broadway, Kingston, NY 12401. (914) 331-2812 www.teiradservice.com

Multimeters, clamp meters, oscilloscopes, frequency counters, signal generators, component testers, power supplies, other instruments. New and used. Lowest prices in USA. **Free catalog. GEOMA, 601 Academy Street, Elroy, WI 53929-0008. (608) 462-4222.**

Sencore Model CM2125 Monitor Analyzer. Excellent condition. All adapters, cables, manuals, and test leads included. \$1350.00. Contact Chris at Ultimate Video, 908-852-5580.

BUSINESS OPPORTUNITIES

CENTRAL FLORIDA TV/ELECTRONICS Business/Building. Heart of the retirement area. 36 years (75K). Owner retiring. **941-385-0359.**

UPSTATE NEW YORK TV-VCR-SATELLITE repair business. Established since 1952. Owner retiring. (30K) 914-246-2334.

WANTED

WANTED:USED TEST EQUIPMENT. TURN IDLE OR EXCESS EQUIPMENT INTO CASH. AST GLOBAL ELECTRONICS. Voice: 888-216-7159; Fax 814-398-1176; e-mail: sales@astglobal.com.

Green CRT Part Number 251C024080 for Mitsubishi Model **V5-5006R.** Phone: 610-696-5218. Fax: 610-696-1287.

Reader's Exchange

Readers' Exchange is a free service.

The following restrictions apply to Readers' Exchange:

- Only individual readers may use Readers' Exchange, and items must be restricted to those that are ordinarily associated with consumer electronics as a business or hobby. If you're in business to sell the item(s) you want to offer for sale, the appropriate place for your message is in a paid advertisement, not Readers' Exchange.
- Readers' Exchange items must be restricted to no more than three items each for wanted and for sale.
- All submissions must be typed or printed clearly!

Send your Readers' Exchange submissions to:

Readers' Exchange, Electronic Servicing & Technology, 25 Newbridge Road, Hicksville, NY 11801

FOR SALE

23-inch test jig w/lots of Telematic adapters, \$60.00. Sylvania CK3000 test jig w/adapters, \$50.00. Signal source video pattern generator Model 1219, \$225.00. Heathkit CRT tester rejuvenator Model ST5230, \$40.00. Eico 1100 resistor substitution box, \$10.00. Eico 1120 capacitor substitution box, \$10.00. Quasar service kit w/24 modules, \$50.00. Sylvania GTE service kit w/18 modules & 350 resistors, \$60.00. Assortment of Walsco phono drives & tape recorder belts, \$25.00. Tube assortment 93 large octal base, compactron & others (185) 7 & 9 pin miniatures plus a caddy w/106 tubes, all \$125.00. Two multiple draw cabinets w/ICs, transistors, electrolytics & pilot lamps, all for \$50.00. Kenwood TR2500 2-meter radio w/AC charger, DC charger mobile base, Mic, \$200.00. S&H not included. *Contact: Ed, 603-669-1533 or E-mail, ededuc@prodigy.net.*

Bird Model 43 wattmeter, excellent condition, manual, \$185.00. Sencore SG165 am/fm stereo analyzer, excellent condition, all probes, manual, original box, \$450.00. Model 43 wattmeter element, 100 watt, 100-250 MHz, \$50.00. All prices plus shipping. *Contact: Lloyd Spivey, 1203 Charlotte Lane, Hartford, KY 42347, 270-298-7159.*

B&K 2160 60 MHz dual trace oscilloscope, little use, like new, in box, \$550.00 plus s&h. Will consider trade for TENTE test instruments. *Contact: Robert Morrison, 10238 117th Lane, Live Oak, FL 32060-6716, e-mail rrmorison@susannevalley.net.*

Channel master broad band VHF distribution amplifier. Sams Photofact. *Contact: Ann Bichanich, 15 W. Lake St., Chisholm, MN 55719.*

Sharp VHS camcorder Model VL-L80UA with all accessories and manuals, \$100.00. *Contact: Frank, 727-392-0230.*

B&K 545 in-circuit component analyzer with autoscan (unused), \$1750.00. *Contact: Kim Gutzke, 612-869-4963.*

Electronic equipment (all mint condition), parts, tech books and educational VHS-video. Send S.A.S.E. for list. *Contact: Ralph Bianco, 1431 Robinson Ave., Havertown, PA 19083.*

Jerrold CM-10 marker generator. Jerrold 601 sweep generator. Scala super marker injector. Best offer. *Contact: Richard Gilman, P.O. Box 633, King City, CA 93930, 831-385-9248.*

WANTED

Photofact #2544 to 3761. *Contact: Patrick Willie, 520-871-2139, P.O. Box 933, Fort Defiance, AZ 86504.*

Zenith Trans Oceanic Model Royal D7000Y schematic. *Contact: N. Young, 214E Robertson St., Brandon, FL 33511, 813-685-1900.*

Tool to coil, to spool electrical wire like Olympic Instruments Model 99. *Contact: Rejean Mathieu, 819-874-1049, (fax) 819-874-0704.*

Sony Watchman Model FD402A cable (VK120-A). *Contact: Joe, 208-865-2216.*

Sams "MHF" (Modular Hifi) manuals (set), preferably complete but will take what you have. Also any 60s-70s Marantz, Phase Linear, SAE, Acoustech or C/M labs info. *Contact: Mike Zuccaro, 8795 Corvus, San Diego, CA 92126, 858-271-8294, E-mail mjzuccaro@aol.com.*

Sharp Model 35LD986 chassis #35L1. *Contact: Neil Kummerer, 2436-20 Aven. No., St. Petersburg, FL 33713, Phone: 727-526-5551.*

Coming next month...

Soldering and desoldering update

Electronics engineers keep finding ways to reduce the size of components and pack more functionality into integrated circuit packages. That means that consumer electronics products increasingly contain components that have more pins that are thinner and more closely spaced. The challenge for the service technician is to learn how to desolder these devices from the circuit without damaging the circuit board traces, and solder in a new one without damaging it with excessive heat, or creating solder bridges between pins. This article will provide technicians with tips on how to accomplish these daunting tasks.

Circuit board and parts handling

As components become smaller and more tightly packed together in consumer electronics products, and the pin count on IC's keeps increasing, the servicing technician has to exercise greater care in handling the components and circuit boards. This article will contain information and suggestions on the latest methods and products for dealing with PC board and parts handling problems.

Software, diagnostic

The nature of personal computers is such that if a computer is faulty, but operating at least to some degree, the use of a diagnostic software package may be able to test out many of the computer's circuits. In some cases, the right diagnostic software can pinpoint where the problem lies, or at least give some idea of where to look to perform further tests. This article will provide information on some useful diagnostic software, and will present some tips and suggestions on how best to use this software to solve problems in personal computers.

Microwave oven servicing

Microwave ovens are somewhat different from most of the electronics products in the home. It's really an appliance rather than an entertainment product. And it contains parts that handle large amounts of power. Moreover, the circuitry is considerably different from circuits in most other electronics products. But microwave ovens are electronic in nature, and a savvy consumer electronics technician can fix them. This article will discuss a number of problems that befall microwave ovens, and provide some suggestions on restoring them to operation when they fail.

TUBES • TUBES • TUBES
World's Largest Range
 Over 2,000 Types, Domestic & Foreign
 UP TO 85% OFF Ask for price list
International Components Corporation
 Toll Free 800-645-9154 • N.Y. State 516-293-1500
 107 Maxess Road, Melville, New York 11747

Circle (64) on Reply Card

Do You Repair Electronics?
 Repair Databases for
 TV, VCR, Monitor, UL
 Audio, FCC, and more.

- Over 76,000 records
- Private user forums
- Live on-line chat rooms

RepairWorld.com
 Electronix Corp | Herald Sq. Fairbairn, OH 45324 (937) 878-9878

Circle (63) on Reply Card

The nation's one source for brand name electronics parts, accessories and literature from

a z

Tritronics
 INCORPORATED

aiwa PHILIPS
Beltz Crocker **RCA**
DENON SANYO
FISHER GENERAL ELECTRIC SHARP
HITACHI SONY
JVC TOSHIBA
MAGNAVOX WELBILT
Panasonic ZENITH

1-800-638-3328
 1-800-888-FAXD

Circle (69) on Reply Card

Monitor Test Equipment
www.computermonitor.com

- Sweep rates to 64kHz
- Gray Scale/Color Bars
- "AutoScan" (auto rate switching)
- Portable & Bench units
- Patented

LOW COST

CMM 1-800-466-4411, 770-662-5633
 Visa-MC-AMX-Discover—On-line ordering

Circle (68) on Reply Card

<http://www.electronic-servicing.com>

Check out our Web Site at

WE'RE ON THE WEB!

CHECK US OUT!

Advertisers' Index

Company	Page Number	Reader Service Number	Advertiser Hotline
B & D Enterprises	5	62	888/815-0508
CES	IFC	120	703/907-7605
CEMA	16	65	703/907-7670
Computer & Monitor Main.....	64	68	800/466-4411
Electronic Design Specialist.....	21	61	561/487-6103
Electronic Servicing & Tech.	61	800/853-9797
Electronics Technicians Assoc.....	57	72	800/288-3824
Electronix Corporation	64	63	937/878-1828
International Components Corp.....	64	64	800/645-9154
Iscet	15	2	817/921-9101
MCM Electronics.....	51	66	800/543-4330
Prelco.....	9	7	888/773-5268
Sams & Company, Howard.....	53	118....	800/428-SAMS
Sencore	IFC	1	800/736-2673
Thomson Consumer Electronics	BC	67	800/336-1900
Tritronics, Inc.	64	69	800/638-3328

We'd like to see your company listed here too. Call Robin Torrey at 630-584-5333 Ext 18 or Fax him at 630-584-9289 to work out an advertising program tailored to suit your needs.

What's Your Best Servicing Value?
 The magazine that makes money for you –

ELECTRONIC
 Servicing & Technology

Each month, *ES&T* brings you how-to service articles on TVs...VCRs... Computers... CD players... Microwaveovens... Audio products and more. It's the information you need to do your job everyday.

Regular columns and special features from experts will make you more efficient – and more profitable – in no time. Plus, our monthly PROFAX, a FREE 8-page pull-out of popular TV, VCR and computer schematics, makes *ES&T* an even greater value.

1-year, (12 issues) \$26.95
 1-year Canada/Mexico \$36.95
 1-year Foreign Air Post, \$44.95

2-years, (24 issues) \$49.95
 2-years, Canada/Mexico \$69.95
 2-years Foreign Air Post, \$85.95

Electronic Servicing & Technology
 25 Newbridge Road, Hicksville, NY 11801 • Phone: 516-681-2922 • FAX: 516-681-2926

Technology Playground

Discover the amazing, emerging technologies
that could be the inspiration for your next, best idea.

Explore the engineering fantasyland
at the 2000 International CES.

2000 International

CES

Your Source for Workstyle
and Lifestyle Technology

January 6-9, 2000
Las Vegas, Nevada USA
Register now!
Visit www.CESweb.org

Circle (12C) on Reply Card

Video Heads

Pick A Number Any Number

When you're looking for a replacement head, SK Series is way *ahead* of the competition.

SK Series replacement video heads cross over to 4,500 different models and 68 different brands.

And when you're in need of any exact semiconductors, belts, tires, flyback transformers or video replacement parts, we have them too.

But we don't stop there.

Every SK Series product comes with the quality assurance and accuracy you expect from all Thomson products.

For more information on SK Series products, contact your nearest Thomson Distributor.

SK Series...The parts you need to do the job. "Trust me!"

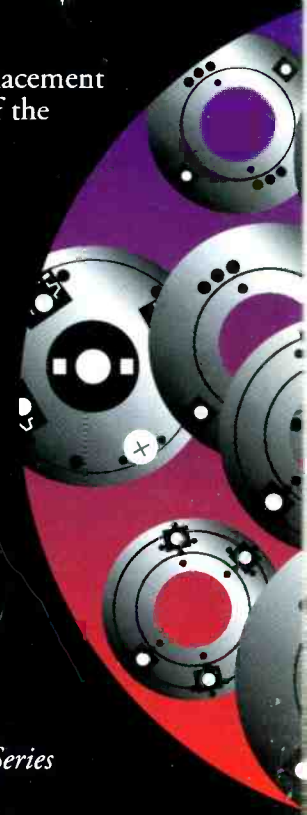

THOMSON CONSUMER ELECTRONICS

SK

Series

Circle (67) on Reply Card